

TUNABLE WHITE DMX WET LOCATION POWER SUPPLIES

24VDC OUTDOOR CONSTANT VOLTAGE

REV 04.22.21



PSB-100W-24VDC-2XK-W



PSB-2X100W-24VDC-2XK-W

DESCRIPTION

Our Surface Mount, exterior-rated Tunable White supplies utilize drivers for powering 24VDC constant voltage products. These products are the ideal power supplies for all Color Changing, damp or wet LED lighting solutions. Our constant voltage LED Power Supplies for outdoor environments are designed to provide regulated voltage through the DMX driver to the LED module. Designed for outdoor Cirrus, Soft Strip and Flex Neon.

- Universal Input Voltage
- Ripple Free
- IP65 – For Both Indoor and Outdoor Use
- No Minimum Load Requirement
- Class 2, Class P
- Auto-Reset Protection for Short Circuit & Over-Temperature
- Over Load Protection – CC Mode

CONTROLS

- CDMX1-2XK - Single zone DMX touch controller
- CTP - Multiple zone DMX touch controller

POWER INPUT

Universal Input voltage ranging from 120 to 277VAC

DIMENSIONS

PSB-100W-24VDC-2XK-W

Length: 10"
Width: 7.1"
Height: 3.3"
Weight: 1.6lbs

PSB-2X100W-24VDC-2XK-W

Length: 11.8"
Width: 9.1"
Height: 3.4"
Weight: 2.26lbs

LABELS

Assembled in America, Class P, Class 2, IP65, 120-277V, Dimmable, RoHS Compliant, 24VD

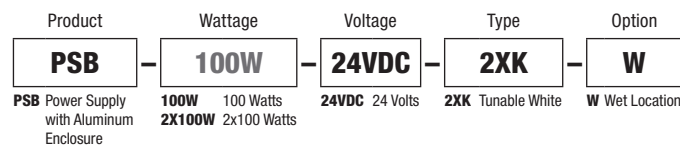

REQUIRED COMPONENTS SOLD SEPARATELY

WIRING DIAGRAM

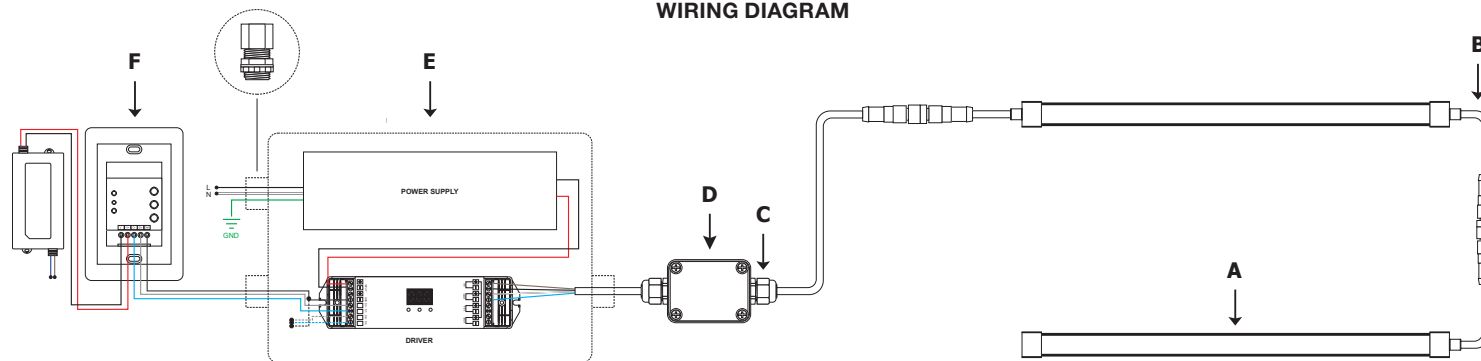

A. OUTDOOR 24VDC FIXTURE OR FLEX NEON

Wet location Cirrus, Flex Neon or Soft Strip. Please refer to fixture ordering code for incremental lengths. Cirrus, Flex Neon and Soft Strip are not field cuttable or submersible.

B. POWER CABLE CONNECTOR

The flexible power cable connector is designed to work in outdoor environments for safe and reliable connections.

C. POWER CONNECTOR

Sold Separately for Cirrus, Flex Neon and wet location Soft Strip.
*Included with Wet Location LED Soft Strips - comes connected to each end of the LED Soft Strip sealed in water-resistant silicone.

D. OUTDOOR CONNECTION BOX

Wet-rated low voltage Splice Box with connectors.

E. OUTDOOR RATED POWER SUPPLY WITH DMX DRIVER

Outdoor rated Power Supplies are required for use with a Outdoor LED Soft Strip and fixtures.

F. CONTROLLER (SOLD SEPARATELY)

CDMX1-2XK or CTP

PROJECT	FIXTURE TYPE	DATE
---------	--------------	------

RECOMMENDED CONTROLLERS

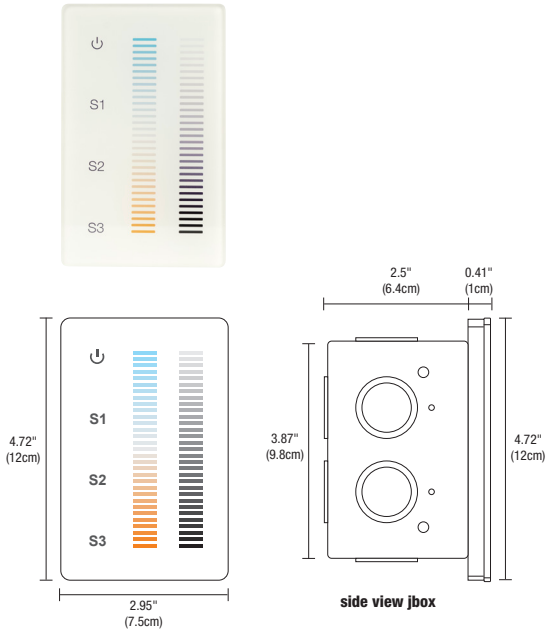

DESCRIPTION:

The Tunable White Touch Controller offers fast and accurate Color Temperature adjustment and the ability to regulate the Brightness Independently. The modern Glass faceplate features illuminated indicators, and a back-lit night light that softly illuminates the controller when powered off. Designed for Tunable White, and dual-color LED installations within a single zone. The two Vertical Touch sliders are precise and sensitive, allowing you to fine-tune your perfect Color Temperature at any point between **2000K** (Sunset) to **6500K** (Daylight White) while selecting over **250 levels** of Brightness in a smooth, uninterrupted transition. Create Thousands of White Color Combinations while maintaining even Brightness and overall saturation. Easily save three pre-set scenes for different times of the day. Support health, performance, and general well-being using Human-Centric lighting by fine-tuning the biological effects that light has on the circadian cycle using the latest in LED technology. Includes a power adapter that fits behind the controller within a standard junction box and fits inside a standard single-gang receptacle (not for use in a multi-gang box). Use with an insulated, 24 AWG stranded, tinned copper wire (Belden #9841). Power Supplies are Sold Separately. Includes a 5 year pro-rated warranty.

APPLICATIONS:

Indoor

INSTALLATION:

Fits in a single gang 2.5" deep junction box.
Not compatible with multi-gang boxes.

POWER INPUT:

120-240VAC

OUTPUT SIGNAL:

USITT DMX 512 (1990)

LABELS:

ROHS, FCC, Damp Location, ETL/UL

Controller **NOT** wet rated, install in dry location or use electrician supplied wet location rated cover.

Product	Type	Finish
CDMX1	2XK	WH
CDMX1 DMX Single Zone Touch Controller	2XK 2 X Kelvin	WH White

RECOMMENDED CONTROLLERS: Tunable White Wiring with CDMX1-2XK

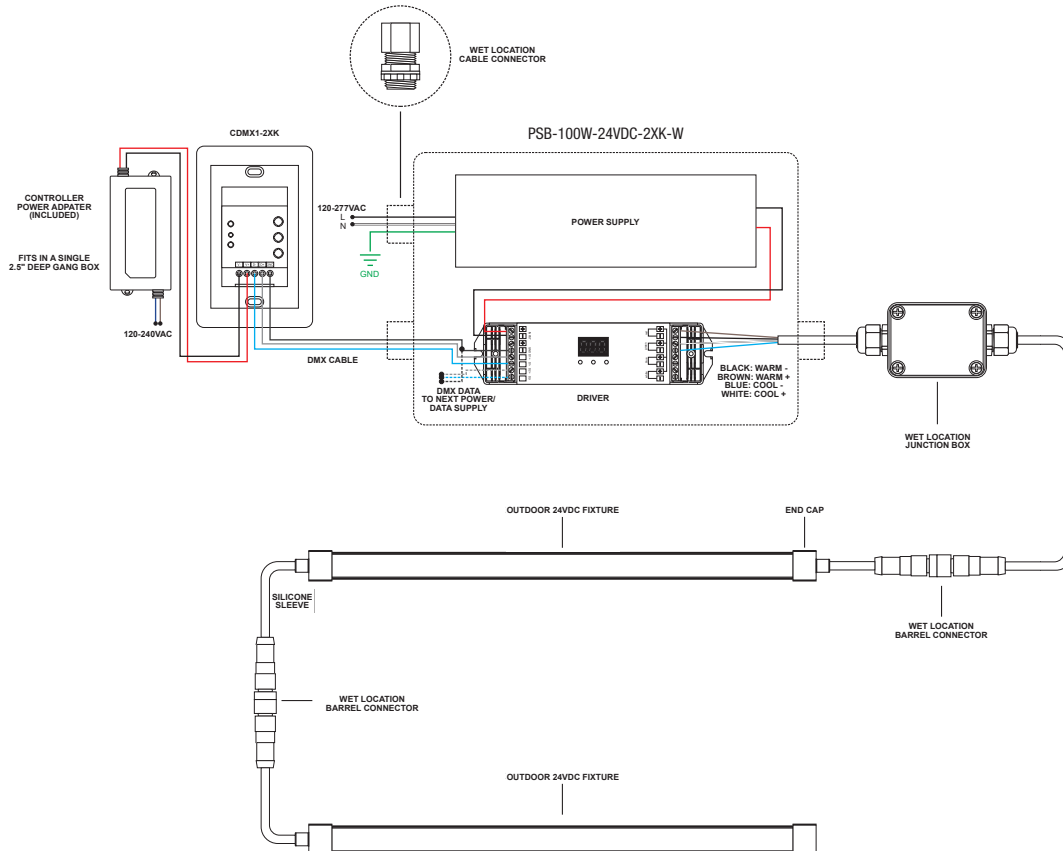

PROJECT	FIXTURE TYPE	DATE

TUNABLE WHITE DMX WET LOCATION POWER SUPPLIES

24VDC OUTDOOR CONSTANT VOLTAGE

REV 04.22.21

RECOMMENDED CONTROLLERS

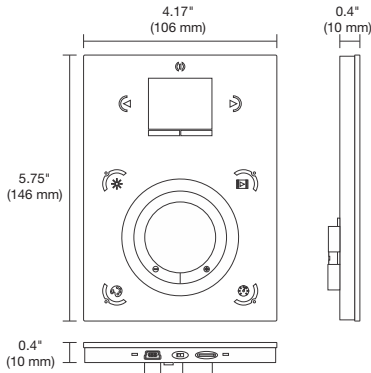
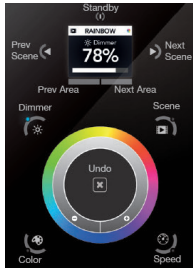

DESCRIPTION:

Full touch controller offers fast and accurate color tone adjustment and independent brightness control. The 10 zone controller can adjust RGB and RGBW LEDs smoothly and accurately. Independent smooth dimming of each channel enables the controller to achieve millions of colors. For indoor applications only, and includes a Power Adapter to operate the controller.

APPLICATIONS:

Indoor

POWER ADAPTER:

9VDC 0.65A (included)

POWER INPUT:

7VDC 0.6A

OUTPUT SIGNAL:

DMX512 1,024 channels total

INPUT SIGNAL:

Universal IR receiver (Sold Separately), RS232, Contact Closure, Live Computer Link, DMX512, WiFi

CONNECTIONS:

USB, Ethernet, RS232, Clock, 8 dry contact ports, open drain output

MEMORY:

microSD (32GB Max)

COMPUTER AND MOBILE DEVICE REQUIREMENTS:

IPHONE/IPAD/ANDROID:

The controller may be used with any of the following apps: DMX Lightpad 3, Easy Remote and Arcolis may be downloaded from App Store or Google Play.

ESA PRO SOFTWARE (WINDOWS ONLY, TIMELINE AND MULTI-ZONE):

Windows ME, XP, Vista, 7 or 8 (32 bits and US 2.0, computer connection required for initial setup only.)

ESA2 SOFTWARE (WINDOWS/MAC, SINGLE ZONE):

Windows ME, XP, Vista, 7 or 8
Mac OS X 10.7 (Lion), 10.8 (Mountain lion), 10.9 (Mavericks), 10.10 (Yosemite)

Controller **NOT** wet rated, install in dry location or use electrician supplied wet location rated cover.

RECOMMENDED CONTROLLERS: Tunable White Wiring with CTP

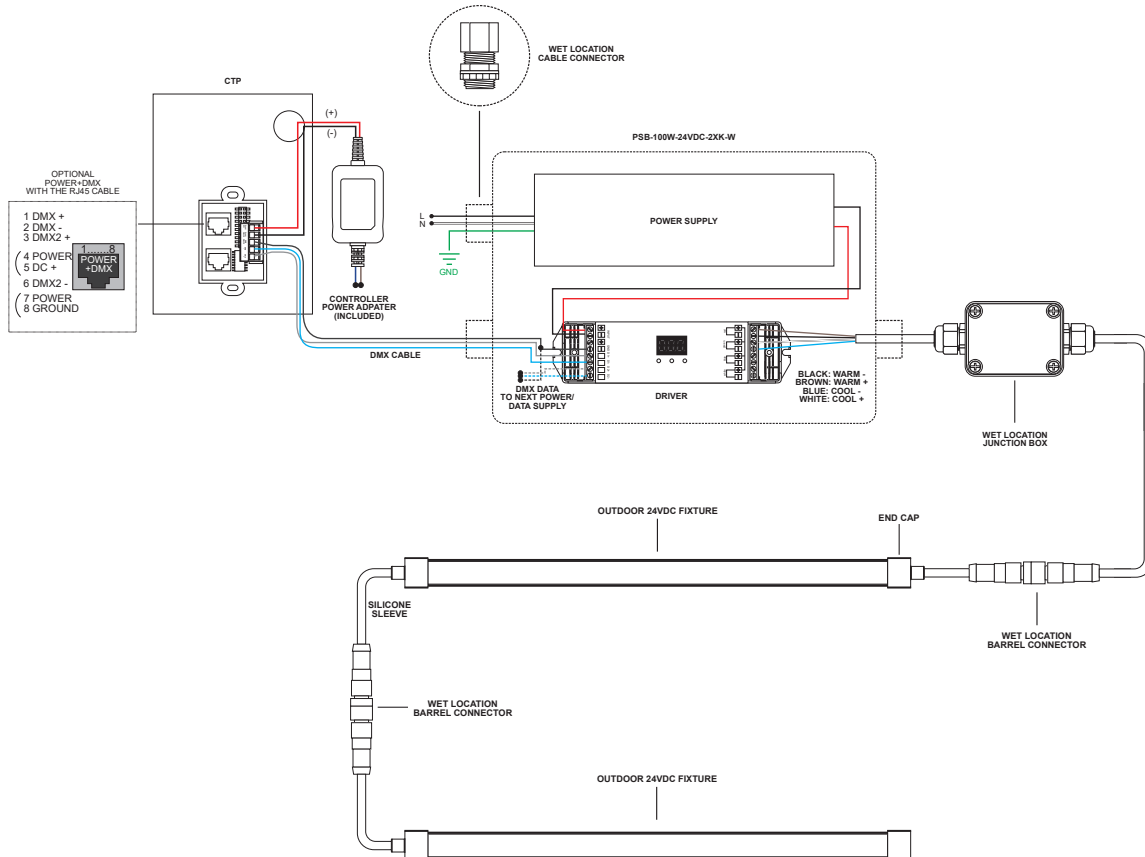
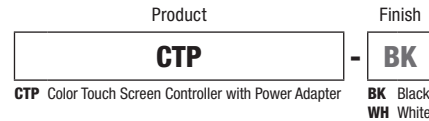

PROJECT	FIXTURE TYPE	DATE
---------	--------------	------