

STEP 1 Cut into 5/8" drywall.

STEP 2 Plaster.

STEP 3 Paint ceiling & add T24 Track Heads & White Plastic Cover.

DESCRIPTION

TruTrack is a plaster-in recessed 24VDC single circuit track that is only as thick as the 5/8" drywall, eliminates the concern of hitting studs, and allows more flexibility to make turns along the ceiling. For a complete and clean architectural look, a paintable slot cover will be supplied with TruTrack so only the Track Head will be visible once installed.

FEATURES

- Design for use with a 24VDC Remote Power Supply up to 40' away
- With Remote Power Supply, smaller Track Heads can be utilized for a refined look
- Track Heads come in two options, Warm Dim - 3000K dims to 1900K, 95 CRI or 3000K Standard Dim
- Track Head Lumen Output from 6 Watts, 539 Lumens to 8.7 Watts, 690 Lumens, with 4 different Beam Spreads to choose from
- Power Feeds may be ordered in End, Center, L, T, and X, up to 200 Watts before re-feeding, 400 Watts at Center Feed
- Recessed TruTrack Channel is available in 2', 4', 6', and 8' lengths, with the ability to be cut at the job site
- White Plastic Cover is included with TruTrack Channel to hide Recessed Track Slot and may be painted to match the ceiling
- 10 gauge bus bar to help eliminate voltage drop

FINISH & MATERIAL

- White Powder Paint
- Extruded Aluminum Channel, conductors are a pair of #10 gauge copper bus

APPLICATIONS

Suitable for damp or dry location. Interior use only

INTEGRAL LED LAMP

- 30D (Warm Dim 3000K-1900K) or 30K (3000K Standard Dim)
- 50,000 Hour Lamp Life

24VDC POWER SUPPLIES (SOLD SEPARATELY)

- 24VDC Low Voltage Remote Power Supply, from 25-2x200 Watts
- 25 Watts, 100 Watts UL Class 2 or 200 Watts UL 2108
- 0-10V Dimming (0-10V up to 200 Watts), Remote only
- Lutron Hi-lume®, Remote only

WARRANTY / LABELS

5 year warranty. Assembled in America
ETL (Conforms to UL 1598 and CSA 22.2 #250.0), California Title 24: 4th quarter 2018



| | | |
|---------|--------------|------|
| PROJECT | FIXTURE TYPE | DATE |
|---------|--------------|------|



SINGLE CIRCUIT RECESSED 24VDC TRACK

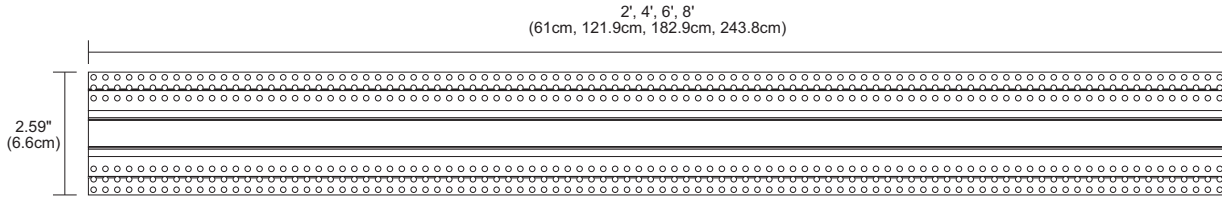

SINGLE CIRCUIT TRACK

Made of extruded Aluminum Channel with 10 gauge bus bar to help eliminate voltage drop and is designed for use with 24VDC Remote Power Supply, sold separately. Includes two Opaque Covers for Track Slot.

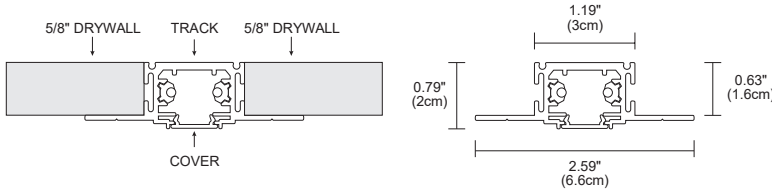

| System | Circuit | Length in Feet | Color |
|------------------------|-------------------|--------------------------------------|-----------------------|
| TR24 | 1C | 8FT | WH |
| TR24 TruTrack Recessed | 1C Single Circuit | 2FT 2' 4FT 4' 6FT 6' 8FT 8' | WH White Powder Paint |

OPAQUE SLOT COVER

Included with each Recessed Track are two paintable Plastic Slot Covers.



| System | Type | Length in Feet | Color |
|--------------------------|---------------------------------|----------------|-----------|
| T24 | SCO | 8FT | WH |
| T24 Track Recessed 24VDC | SCO Opaque Cover for Track Slot | 8FT 8' | WH White |

COMPONENTS Power Feeds

END POWER FEED WITH JUNCTION BOX



| System | Type | Cover Size | 24VDC Power Supply (Title 24 Compliant) | Drywall | Color |
|------------------------|-----------------------------------|---|---|--------------------------|----------------|
| TR24 | EP1 | 1RE | RT | ST | WH |
| TR24 TruTrack Recessed | EP1 End Power Feed Single Circuit | 1RE 1" Rectangle raised Cover over standard 2.5" J-box for Remote Power Supply only | RT 24VDC Remote Power Supply (Not Included) | ST Standard 5/8" Drywall | WH White Cover |

END POWER FEED

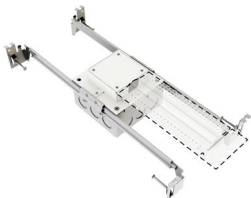

| System | Type | Cover Size | 24VDC Power Supply (Title 24 Compliant) | Drywall | Color |
|------------------------|-----------------------------------|--|---|---|----------------|
| TR24 | EP1 | 3SQ | RT | AJ | WH |
| TR24 TruTrack Recessed | EP1 End Power Feed Single Circuit | 3SQ 3" Square Cover on standard 2.5" deep Electrical J-box for Remote Power Supply | RT 24VDC Remote Power Supply (Not Included) | ST Standard 5/8" Drywall AJ 0.75"-1.5" Drywall | WH White Cover |

| | | | | | |
|---------|--|--------------|--|------|--|
| PROJECT | | FIXTURE TYPE | | DATE | |
|---------|--|--------------|--|------|--|

COMPONENTS Power Feeds (cont'd)



CENTER POWER FEED WITH JUNCTION BOX



| System | Type | Cover Size | 24VDC Power Supply (Title 24 Compliant) | Drywall | Color |
|------------------------|--------------------------------------|---|---|--------------------------|----------------|
| TR24 | CP1 | 1RE | RT | ST | WH |
| TR24 TruTrack Recessed | CP1 Center Power Feed Single Circuit | 1RE 1" Rectangle raised Cover over standard 2.5" J-box for Remote Power Supply only | RT 24VDC Remote Power Supply (Not Included) | ST Standard 5/8" Drywall | WH White Cover |

CENTER POWER FEED

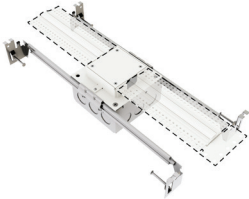

| System | Type | Cover Size | 24VDC Power Supply (Title 24 Compliant) | Drywall | Color |
|------------------------|--------------------------------------|--|---|---|----------------|
| TR24 | CP1 | 3SQ | RT | ST | WH |
| TR24 TruTrack Recessed | CP1 Center Power Feed Single Circuit | 3SQ 3" Square Cover on standard 2.5" deep Electrical J-Box for Remote Power Supply | RT 24VDC Remote Power Supply (Not Included) | ST Standard 5/8" Drywall AJ 0.75"-1.5" Drywall | WH White Cover |

L-SHAPED POWER CONNECTOR

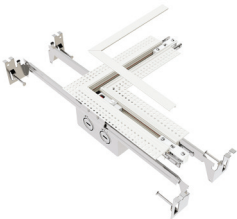

| System | Type | Cover Size | 24VDC Power Supply (Title 24 Compliant) | Drywall | Color |
|------------------------|---|---|---|--------------------------|----------------|
| TR24 | LP1 | 1RE | RT | ST | WH |
| TR24 TruTrack Recessed | LP1 L-Shaped Power Connector Single Circuit | 1RE 1" Rectangle raised Cover over standard 2.5" J-box for Remote Power Supply only | RT 24VDC Remote Power Supply (Not Included) | ST Standard 5/8" Drywall | WH White Cover |

L-SHAPED POWER FEED WITH JUNCTION BOX

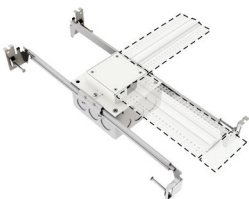

| System | Type | Cover Size | 24VDC Power Supply (Title 24 Compliant) | Drywall | Color |
|------------------------|-----------------------------------|--|---|---|----------------|
| TR24 | LP1 | 3SQ | RT | ST | WH |
| TR24 TruTrack Recessed | LP1 L-Shaped Power Single Circuit | 3SQ 3" Square Cover on standard 2.5" deep Electrical J-Box for Remote Power Supply | RT 24VDC Remote Power Supply (Not Included) | ST Standard 5/8" Drywall AJ 0.75"-1.5" Drywall | WH White Cover |

L-CONNECTOR

Conductive or Non-Conductive L-Connector joins two straight TruTrack Channels together to make a 90° angle. Order Non-Conductive when adding two Power Supplies in a square configuration.

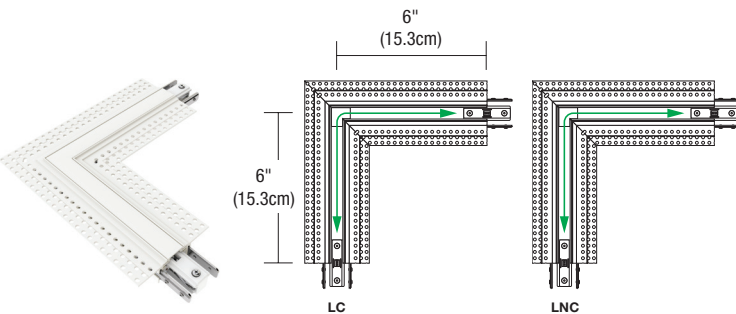

| System | Type | Length in Inches | Color |
|------------------------|---|------------------|----------------|
| TR24 | LC | 6IN | WH |
| TR24 TruTrack Recessed | LC L-Connector Conductive LNC L-Connector Non-Conductive | 6IN 6" | WH White Cover |

| | | |
|---------|--------------|------|
| PROJECT | FIXTURE TYPE | DATE |
|---------|--------------|------|

COMPONENTS Power Feeds (cont'd)



T-SHAPED POWER FEED WITH JUNCTION BOX

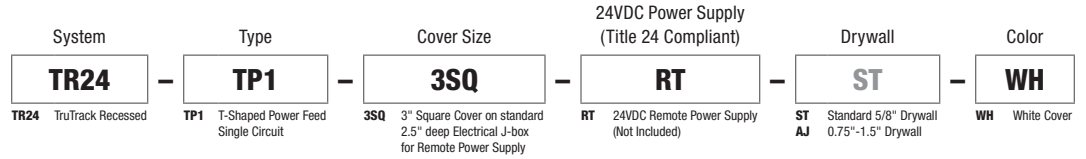
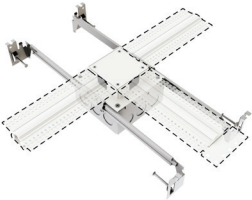

X-SHAPED POWER FEED WITH JUNCTION BOX

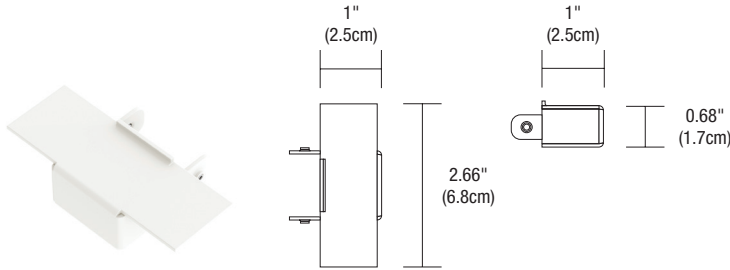
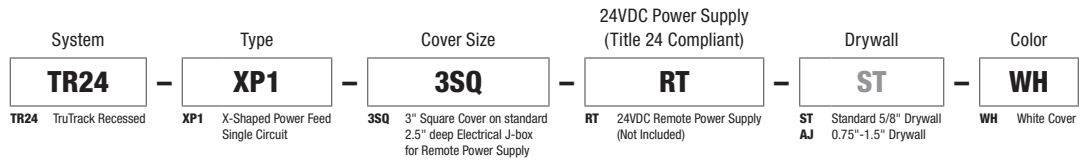

END CAP

Need to order with each dead end of TR24 Track System.

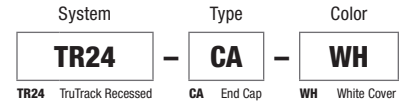



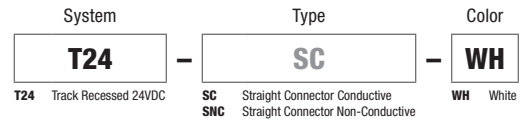
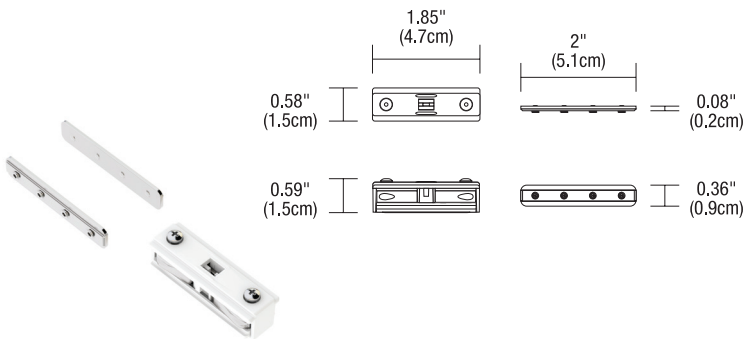

STRAIGHT CONNECTOR

Miniature Straight Connector joins two Track sections end to end and is covered by the Plastic Insert.



| | | |
|---------|--------------|------|
| PROJECT | FIXTURE TYPE | DATE |
|---------|--------------|------|

T24 TRACK HEADS 0-10V DIMMING ONLY

| PRODUCT | RADIANT LARGE | RADIANT MEDIUM | TUBO LARGE | TUBO SMALL | DELTA SMALL |
|--|---|---|--|---|---|
| T24 WARM DIM TRACK HEADS COMPARISON CHART |  |  |  |  |  |
| WARM DIM ORDERING CODE | T24-RADL-FL-30D-(BK OR WH) | T24-RADM-FL-30D-(BK OR WH) | T24-TUBL-FL-30D-(BK OR WH) | T24-TUBS-FL-30D-(BK OR WH) | T24-DELS-FL-30D-(BK OR WH) |
| STANDARD STATIC WHITE ORDERING CODE | T24-RADL-FL-30K-(BK OR WH) | T24-RADM-FL-30K-(BK OR WH) | T24-TUBL-FL-30K-(BK OR WH) | T24-TUBS-FL-30K-(BK OR WH) | T24-DELS-FL-30K-(BK OR WH) |



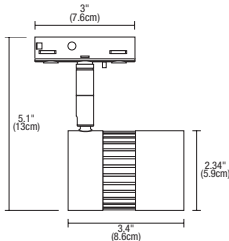
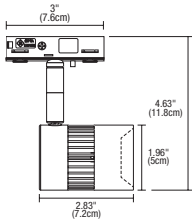
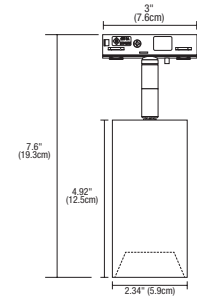
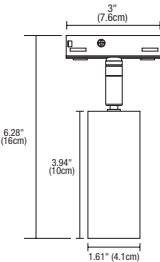
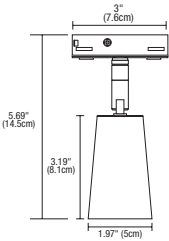

SPECIFICATIONS

| T24 TRACK HEADS |  |  |  |  |  |
|------------------------------|--|--|---|--|---|
| DESCRIPTION | The RADIANT LARGE WARM DIM LED 24VDC TRACK HEAD includes reflector with ordering code that may be changed at the job site. Reflectors give a smooth uniform beam at Spot (SP) 15°, Narrow Flood (NF) 25°, Flood (FL) 40° or Wide Flood (WF) 60° beam spreads. | The RADIANT MEDIUM WARM DIM LED 24VDC TRACK HEAD includes reflector with ordering code that may be changed at the job site. Reflectors give a smooth uniform beam at Spot (SP) 20°, Flood (FL) 40° or Wide Flood (WF) 60° beam spreads. | The TUBO LARGE WARM DIM LED 24VDC TRACK HEAD includes reflector with ordering code that may be changed at the job site. Reflectors give a smooth uniform beam at Spot (SP) 15°, Narrow Flood (NF) 25°, Flood (FL) 40° or Wide Flood (WF) 60° beam spreads. | The TUBO SMALL WARM DIM LED 24VDC TRACK HEAD includes reflector with ordering code that may be changed at the job site. Reflectors give a smooth uniform beam at Spot (SP) 20°, Flood (FL) 40° or Wide Flood (WF) 60° beam spreads. | The DELTA SMALL WARM DIM LED 24VDC TRACK HEAD includes reflector with ordering code that may be changed at the job site. Reflectors give a smooth uniform beam at Spot (SP) 20°, Flood (FL) 40° or Wide Flood (WF) 60° beam spreads. |
| WATTAGE | 8.7 WATTS | 8.7 WATTS | 8.7 WATTS | 6.5 WATTS | 6.5 WATTS |
| TOTAL LUMENS* | 638 TOTAL LUMENS | 872 TOTAL LUMENS | 690 TOTAL LUMENS | 428 TOTAL LUMENS | 690 TOTAL LUMENS |
| LUMENS PER WATT* | 73 LUMENS PER WATT | 101 LUMENS PER WATT | 79 LUMENS PER WATT | 65.7 LUMENS PER WATT | 79 LUMENS PER WATT |
| COLOR TEMPERATURE | 3000K WARM DIMS TO 1900K | 3000K WARM DIMS TO 1900K | 3000K WARM DIMS TO 1900K | 3000K WARM DIMS TO 1900K | 3000K WARM DIMS TO 1900K |
| CRI | 96 | 91 | 95 | 98 | 96 |
| R9 | 80 | 51 | 79 | 83 | 82 |
| R13 | 97 | 92 | 97 | 98 | 98 |
| Rf | 93 | 91 | 92.5 | 92.5 | 93 |
| Rg | 100 | 99 | 100 | 101 | 100 |
| FINISH | Available in Black Powder Paint (BK) or White Powder Paint (WH) | | | | |
| MATERIAL | Each T24 Track Head is made from Cast Aluminum | | | | |
| INPUT VOLTAGE | 24VDC | 24VDC | 24VDC | 24VDC | 24VDC |
| FREQUENCY | 50/60HZ | 50/60HZ | 50/60HZ | 50/60HZ | 50/60HZ |
| POWER FACTOR | > 0.90 | > 0.90 | > 0.90 | > 0.90 | > 0.90 |
| APPLICATION | Suitable for damp or dry locations. Indoor use only. | | | | |
| DIMMING & FLICKER | 0-10V dimming Flicker less than 4% | | | | |
| COMPATIBLE DIMMERS | 0-10V or Lutron Hi-lume® | | | | |
| COMPLIANCE LABEL | ETL TO UL 2108 STANDARD | ETL TO UL 2108 STANDARD | ETL TO UL 2108 STANDARD | ETL TO UL 2108 STANDARD | ETL TO UL 2108 STANDARD |
| LED LAMP LIFE | 50,000 HOURS | 50,000 HOURS | 50,000 HOURS | 50,000 HOURS | 50,000 HOURS |

For more detailed information, please view Product Spec Sheet for each Track Head at www.PureEdgeLighting.com

*Lumens & TM-30 Data based on 3000K 40° Beam Spread

REPLACEMENT REFLECTORS FOR TRACK HEADS

| PRODUCT | RADIANT LARGE | RADIANT MEDIUM | TUBO LARGE | TUBO SMALL | DELTA SMALL |
|---|---|---|---|---|-------------------------------|
|  |  |  |  |  | |
| ORDERING CODE | REF-1.75-(SP, NF, FL, WF) | REF-1.375-(SP, FL, WF) | REF-1.75-(SP, NF, FL, WF) | REF-1.375-(SP, FL, WF) | REF-1.375-(SP, FL, WF) |
| REFLECTOR SIZE | 1.75" Diameter | 1.75" Diameter | 1.75" Diameter | 1.375" Diameter | 1.375" Diameter |
| BEAM SPREADS | SP (15°), NF (25°), FL (40°), WF (60°) | SP (20°), FL (40°), WF (60°) | SP (15°), NF (25°), FL (40°), WF (60°) | SP (20°), FL (40°), WF (60°) | SP (20°), FL (40°), WF (60°) |

| | | |
|---------|--------------|------|
| PROJECT | FIXTURE TYPE | DATE |
|---------|--------------|------|

PENDANTS Various Pendants available for TruTrack Recessed



T24-BBCL-10FT-24-WH
Fast Jack Bubble Ball
Fixture Finishes: SN



T24-EVE-PL-24-WH
Fast Jack Everest
Color: Clear (CL), Platinum (PL)
Fixture Finishes: SN, PN, BZ



T24-SALUTI-SM-CR-24-WH
Fast Jack Saluti
Size: 3" (SM), 4" (MD), 5.5" (LG)
Glass Color: Cristallo (CR)
Fixture Finishes: SN, PN, BZ



JC20XE/24 20 WATT 200 LUMENS
JC10XE/24 10 WATT 95 LUMENS
24V G4 Xenon Lamp
JC type G4 Bipin base
low voltage 24V Xenon bulb
2000 hours lamp life

Lamps included with all PureEdge Pendants.
For more Lamp Data, see Product Spec Sheets on PureEdgeLighting.com



T24 FAST JACK FEMALE TRACK CONNECTOR

Use the Fast Jack T24 Female Track Connectors to adapt any Coaxial Pendant fixtures (with 3/32" diameter Coaxial Cable) to PureEdge Lighting TruTrack and Pipeline 24VDC Circuit Systems. 7lbs. weight limit.

| System | Type | Color |
|--------------------------|------------------------|----------------------|
| T24 | FJ | WH |
| T24 Track Recessed 24VDC | FJ Fast Jack Connector | BK Black WH White |



FAST JACK 24VDC MALE CONNECTOR

Fast Jack 24VDC Male Connector use with any Coaxial Pendant fixtures (with 3/32" diameter Coaxial Cable and 24VDC bulb) to PureEdge Lighting TruTrack and Pipeline 24VDC Circuit Systems. 7lbs. weight limit.

| System | Type | Color |
|--------------|-----------------------------|-----------------|
| FJ | MC24 | SN |
| FJ Fast Jack | MC24 Male Connector 24 Volt | SN Satin Nickel |

| | | |
|---------|--------------|------|
| PROJECT | FIXTURE TYPE | DATE |
|---------|--------------|------|

REMOTE POWER SUPPLIES 24VDC 0-10V Compatible Power Supplies (Title 24 Compliant)

| 0-10V (010) POWER SUPPLIES & RECOMMENDED DIMMERS | | | | |
|--|------------------------------|------------------------------|------------------------------|------------------------------|
| ORDERING CODE | PSB-25W-010-24VDC | PSB-60W-010-24VDC | PSB-96W-010-24VDC | PSB-2X96W-010-24VDC |
| SPECIFICATIONS | | | | |
| MAXIMUM LOAD | 25W | 60W | 96W | 2X96W |
| INPUT VOLTAGE | 120VAC | 120-277VAC | 120-277VAC | 120-277VAC |
| OUTPUT VOLTAGE | 24VDC | 24VDC | 24VDC | 24VDC |
| DIMENSIONS | 12.4" X 3.12" X 2.18" | 12.4" X 3.12" X 2.18" | 12.4" X 3.12" X 2.18" | 12.15" X 6.48" X 2.18" |
| CLASSIFICATION | CLASS 2 (TITLE 24 COMPLIANT) | CLASS 2 (TITLE 24 COMPLIANT) | CLASS 2 (TITLE 24 COMPLIANT) | CLASS 2 (TITLE 24 COMPLIANT) |
| IN-WALL MOUNTING | PSB-25W-010-24VDC-IW | PSB-60W-010-24VDC-IW | PSB-96W-010-24VDC-IW | PSB-2X96W-010-24VDC-IW |
| DIMMING & CONTROLS | | | | |
| PHILIPS SUNRISE: SR1200ZTUNV | • | • | • | • |
| LUTRON DIVA: DVTV-WH | • | • | • | • |
| LUTRON NOVA T: NTSTV-DV-XX | • | • | • | • |
| LUTRON GRAFIX EYE QS: QSGRJ-XP | • | • | • | • |
| LUTRON RADIO RA2: RRD-10ND | • | • | • | • |
| LEVITON: LEV40050 | • | • | • | • |
| LEVITON IP710-LFZ | • | • | • | • |
| LEGRAND: ADPD4FBL3P2W4 | • | • | • | • |

| 0-10V (010) POWER SUPPLIES & RECOMMENDED DIMMERS [†] | | | | |
|---|------------------------------|------------------------------|------------------------------|------------------------------|
| ORDERING CODE | PSB-3X96W-010-24VDC | PSB-4X96W-010-24VDC | PSB-200W-010-24VDC | PSB-2X200W-010-24VDC |
| SPECIFICATIONS | | | | |
| MAXIMUM LOAD | 3X96W | 4X96W | 200W | 2X200W |
| INPUT VOLTAGE | 120-277VAC | 120-277VAC | 120VAC | 120VAC |
| OUTPUT VOLTAGE | 24VDC | 24VDC | 24VDC | 24VDC |
| DIMENSIONS | 14" X 10" X 3" | 17" X 13" X 3" | 12.15" X 6.48" X 2.18" | 14" X 10" X 3" |
| CLASSIFICATION | CLASS 2 (TITLE 24 COMPLIANT) | CLASS 2 (TITLE 24 COMPLIANT) | UL1598* (TITLE 24 COMPLIANT) | UL1598* (TITLE 24 COMPLIANT) |
| IN-WALL MOUNTING | N/A | N/A | PSB-200W-010-24VDC-IW | N/A |
| DIMMING & CONTROLS | | | | |
| PHILIPS SUNRISE: SR1200ZTUNV | • | • | • | • |
| LUTRON DIVA: DVTV-WH | • | • | • | • |
| LUTRON NOVA T: NTSTV-DV-XX | • | • | • | • |
| LUTRON GRAFIX EYE QS: QSGRJ-XP | • | • | • | • |
| LUTRON RADIO RA2: RRD-10ND | • | • | • | • |
| LEVITON: LEV40050 | • | • | • | • |
| LEVITON IP710-LFZ | • | • | • | • |
| LEGRAND: ADPD4FBL3P2W4 | • | • | • | • |

Classification: UL2108 - * 24VDC over 100 Watts, wires must be in conduit from Remote Power Supply to Junction Box in ceiling.

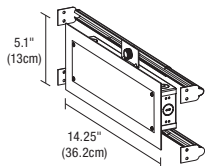

5.1" X 14.25" IN-WALL MOUNTING KIT

Includes Power Supply, Box Cover, and Stud Hangers for installing Junction Box in wall. Select "IW" in the options section of compatible Power Supply ordering codes if an In-Wall Mounting Kit is needed.

ORDERING CODES: PSB-25W-010-24VDC-IW, PSB-60W-010-24VDC-IW, PSB-96W-010-24VDC-IW

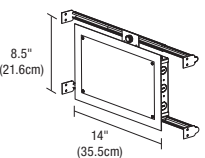

8.5" X 14" IN-WALL MOUNTING KIT

Includes Power Supply, Box Cover, and Stud Hangers for installing Junction Box in wall. Select "IW" in the options section of compatible Power Supply ordering codes if an In-Wall Mounting Kit is needed.

ORDERING CODES: PSB-2X96W-010-24VDC-IW, PSB-200W-010-24VDC-IW

| | | |
|---------|--------------|------|
| PROJECT | FIXTURE TYPE | DATE |
|---------|--------------|------|

REMOTE POWER SUPPLIES 24VDC Lutron Compatible Power Supply (Title 24 Compliant)

| LUTRON HI-LUME® PREMIER .1% ECOSYSTEM® 3-WIRE POWER SUPPLY & RECOMMENDED CONTROLLERS | |
|---|--|
| ORDERING CODE | L3D0-96W24V-U  |
| SPECIFICATIONS | |
| MAXIMUM LOAD | 96W |
| INPUT VOLTAGE | 120-277VAC |
| OUTPUT VOLTAGE | 24VDC |
| DIMENSIONS | 10.5" X 5.5" X 2" |
| CLASSIFICATION | CLASS 2 (TITLE 24 COMPLIANT) |
| DIMMING & CONTROLS | |
| RADIO RA2 | • |
| HOMEWORKS QS | • |
| PHPM-3F-120 | • |
| PHPM-3F-DV | • |
| BCI-0-10 | • |

| REMOTE DISTANCE GUIDE FOR 24VDC, 200 WATT POWER SUPPLIES | |
|---|----------------------|
| DISTANC IN FEET | WIRE GAGE AWG |
| 150' | #8 GAGE |
| 100' | #10 GAGE |
| 50' | #12 GAGE |

| | | |
|---------|--------------|------|
| PROJECT | FIXTURE TYPE | DATE |
|---------|--------------|------|