

Audra

700TDADR_ 1.0



GENERAL PRODUCT INFORMATION:



This product is suitable for indoor dry locations only.

This fixture is intended to be installed utilizing NEC compliant junction boxes.

CAUTION - RISK OF FIRE
This product must be installed in accordance with the applicable installation code by a person familiar with the construction and operation of the product and the hazards involved.
Use minimum 90°C supply conductors.



Assemble the Pendant

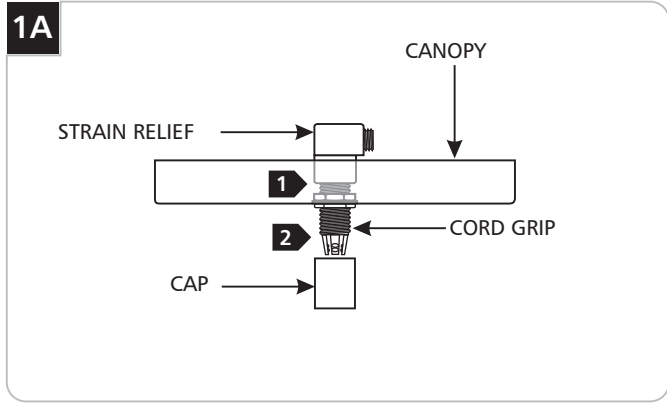

- 1** From back of the canopy tighten the strain relief to the cord grip.
- 2** From front of the canopy remove the cap from cord grip.

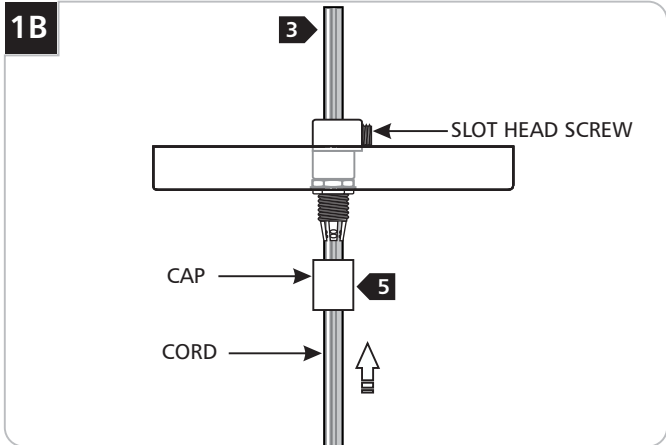

- 3** Feed end of the pendant cord through the cap, cord grip, and strain relief into the canopy.
- 4** Adjust the fixture height (from bottom of the fixture shade to top of the canopy) by moving the cord up or down.
- 5** When desired height is achieved, tighten the cap.

Install the Fixture

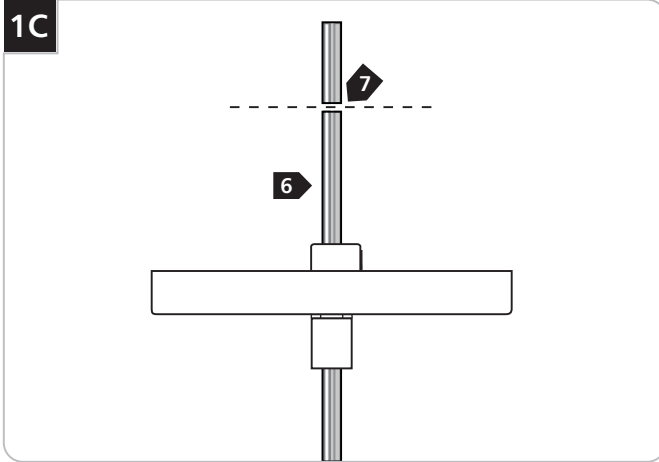

- 6 For power connection, leave at least 6" of the cord exposed in the back of the canopy.
- 7 Cut off the excess cord with a sharp cutter.

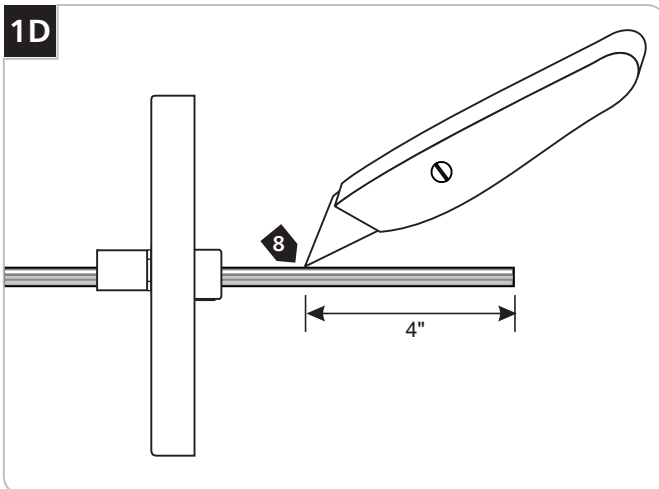

- 8 From the end of the cord, strip the outer insulation 4" using a sharp knife and needlenose pliers. ***Make sure not to cut inner wires.***
- 9 Strip 1/4" of insulation from the inner insulated wires. (three inner insulated wires for standard SVT cord). The bare inner wire is the ground wire (green insulated wire in SVT cord).

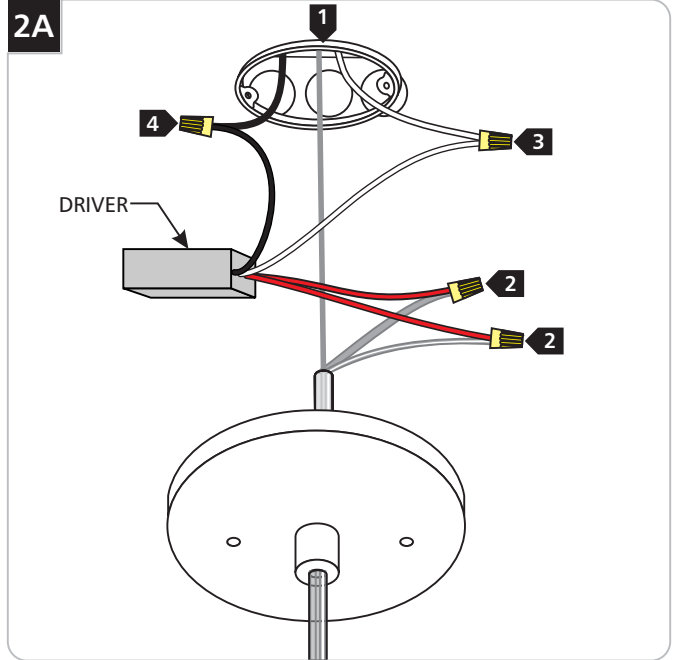

NOTE: If the canopy mounting holes do not match up with electrical box, install the provided universal mounting plate before making wire connections.

- 1 Connect the fixture bare uninsulated wire to the ground in accordance with local electrical codes.
- 2 Connect the insulated pendant wire to each of the red driver wires.
- 3 Connect the white driver wire to the neutral power line wire.
- 4 Connect the black driver wire to the hot power line wire.

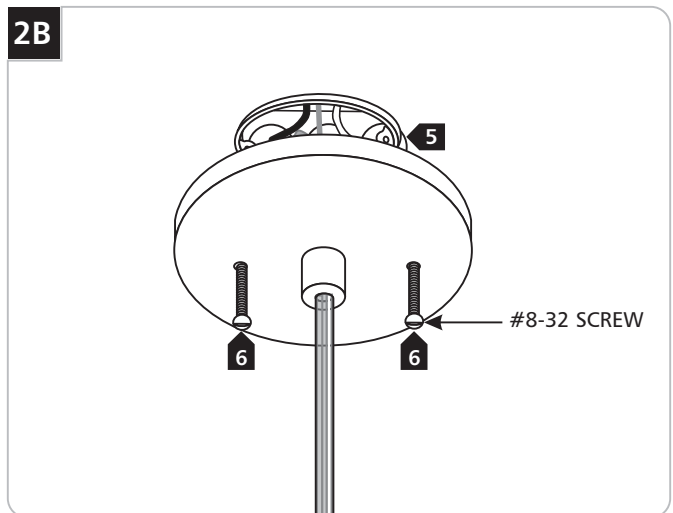

- 5 Place all wires, wire nut connections, and the driver properly inside the canopy.
- 6 Mount the canopy to the electrical box with two #8-32 screws provided.

Replacing the Lamp

CAUTION: To reduce the risk of a burn or electric shock during relamping, disconnect the power to the fixture.

NOTE: lamp shield is for halogen lamping option only.

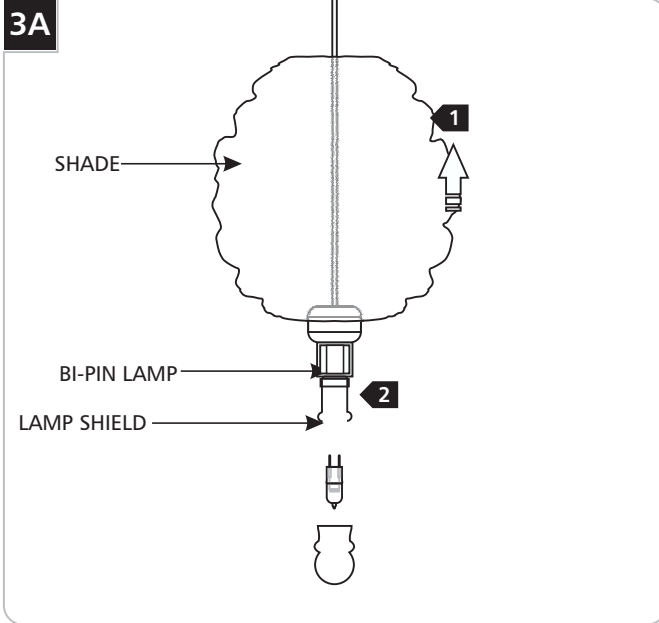

- 1 Slide the glass shade up to expose the socket.
- 2 Remove the lamp shield and the old lamp.

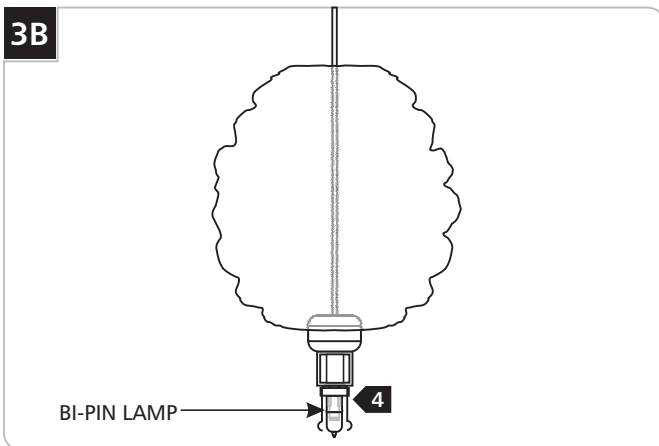

For incandescent versions, use **MAX 35 Watt** Bi-Pin Halogen Lamp.



For LED versions, use provided **MAX 8 Watt** LED Bi-Pin Lamp.

- 3 Handle the new replacement lamp with a soft cloth to prevent the natural oils on the fingertips from collecting on the lamp. This will help extend the life of the lamp.
- 4 Gently insert the new lamp into the socket.

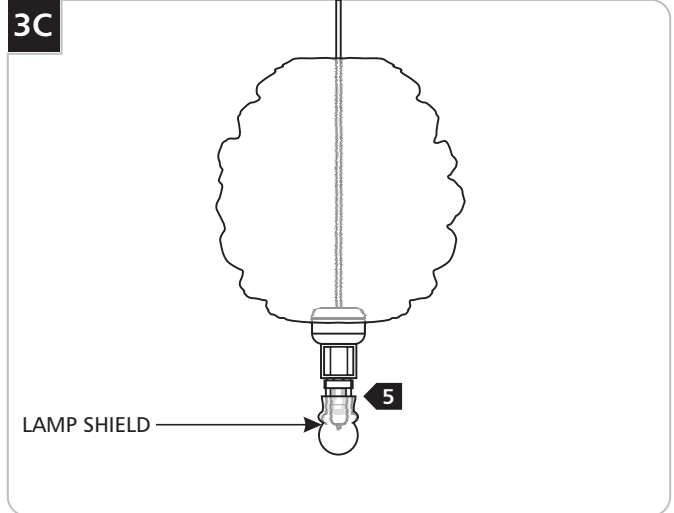

- 5 Push the lamp shield onto the spring clip.

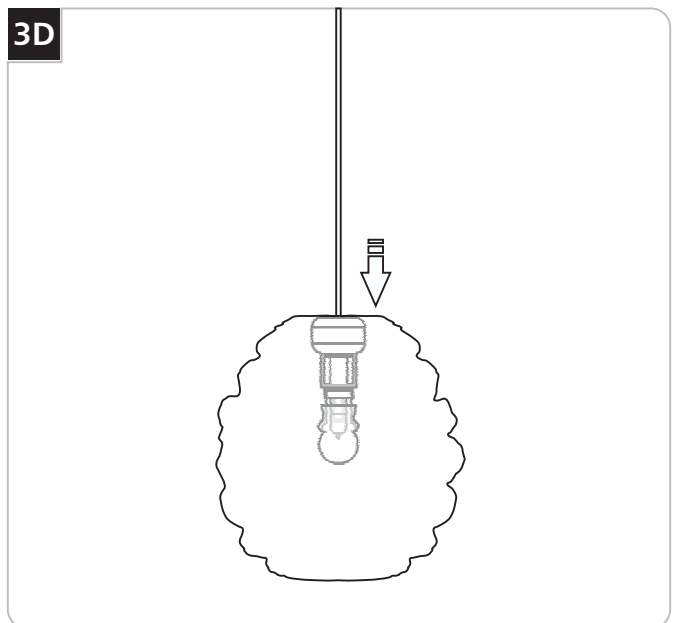

- 6 Gently rest the shade back onto to socket.

IMPORTANT SAFETY INSTRUCTIONS

To reduce the risk of fire, electrical shock, exposure to excessive UV radiation, or injury to person:

- Use this fixture indoors only.
- Do not look directly at the lighted lamp.
- Do not remain in light if skin feels warm.
- Risk of fire: Use only the type of lamp and maximum wattage indicated in this instruction manual.
- Never cover the halogen lamp with anything other than a Tech Lighting lamp shield and never place flammable material close to your fixture.
- Do not touch the fixture shades or lamp shield while the fixture is on. These surfaces may be HOT.
- To avoid glare in child's eyes, hang the fixture at least 18" above a table.

Halogen Lamp General Information

- It is normal for a new halogen lamp to smoke slightly on first use. The protective coating is being vaporized.

Prolonging Halogen Lamp Life

- Do not touch the lamp with bare hands. Any contaminant, even the oil from your hands can deteriorate the lamp. Handle the lamp with a soft, clean cloth. Rubbing alcohol can be used to remove any contaminant from the lamp.
- Do not run the lamps at full power when you do not need to. However, if dimming the fixture for an extended period of time, occasionally bring the light up to full brightness for a few minutes to complete the halogen cycle.

SAVE THESE INSTRUCTIONS!



TECH LIGHTING®

7400 Linder Ave, Skokie, IL 60077

847.410.4400

www.techlighting.com

© 2016 Tech Lighting, L.L.C. All rights reserved. The "Tech Lighting" graphic is a registered trademark of Tech Lighting, L.L.C. Tech Lighting reserves the right to change specifications for product improvements without notification.

A Generation Brands Company