

buoy

Design by
Václav Mlynář

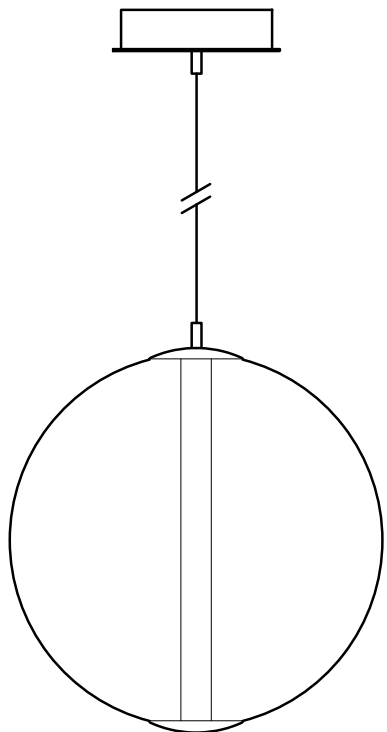

bomma

bomma.cz

TECHNICAL SHEET

BUOY

pendant - sphere

Design by
Václav Mlynář

Handmade glass attributes

All Bomma products are hand-made from mouth-blown lead-free crystal. Therefore any small bubbles, non-melts and irregularities in the glass are both proof and a characteristic feature of this traditional craft.

The Buoy Collection is made by underlying colored glass technology. Thanks to the manual process of blowing underlay glass, each piece is an original. Individual products may vary slightly in intensity, hue or even color. This is an accompanying characteristic of the traditional underlay glass technology.

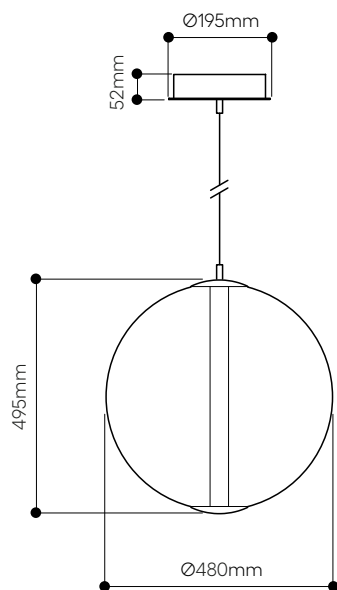

LIGHTING DESCRIPTION

Size	dia 480 mm, H 495 mm dia. 18,9 inch, H 19,5 inch
Cable	black textile braid cable 2,5 m 98,4 inch
Weight	+ - 17 kg / 37,5 lb
Glass	mouth-blown lead-free crystal in clear, white, smoke
Mounting	black (=aluminium black elox), silver (=aluminium silver elox)
Canopy color	black (=matt powder coating)
Protection	IP 20
Nominal voltage	220-240V / A.C. 50-60 hz (EU) 110-120 V / A.C. 60 Hz (USA)
Class	II. EU / I. USA

LIGHT SOURCE

Type	LED module 12,6W, 2700K, 1260Lm,350mA, 36V
Base	custom LED module
Voltage	220-240V, AC (EU) / 110-120V, AC (USA)
Temperature	2700 K
Color index	RA 90+
Dimming	Dimmable with TRIAC, ELV, 0-10V, PUSH, DALI, CASSAMBI

PACKAGING

Material	Cardboard
Size	780 × 660 × 660 mm 30,7 × 26 × 26 inch

Origin: traditionally produced in the Czech Republic
Intellectual property license holder: Bomma Czech Republic (EU)
Represented by BMRC group s.r.o.

CERTIFICATES

