

CARMINA

lampshade | user guide

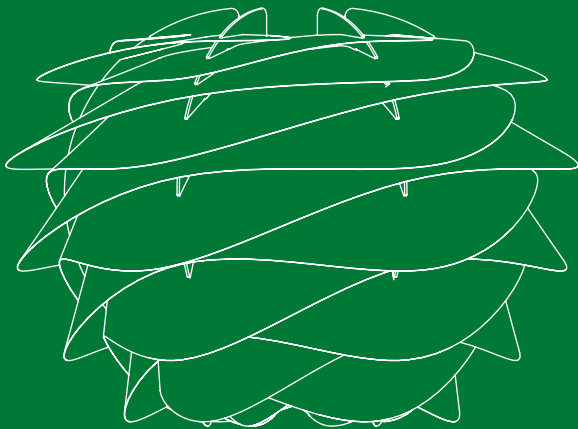

UMAGE



Find assembly video by using the QR code



WITH LOVE FROM COPENHAGEN

At UIMAGE, our designers take inspiration from the distinct nature of the Nordic landscape to create unique designs related to the way we live in an urban setting. Influenced by the design language, colours and materials found around us in Scandinavia, we create a collection that is rooted in our home but designed for everyone.

Versatile, flexible and multifunctional, our designs are created to enhance an urban lifestyle in smaller spaces!



DESIGNED BY SØREN RAVN
CHRISTENSEN & ANDERS KLEM



“ Carmina is designed to
reference the soft waves of
the slow moving dunes of
the many beautiful shorelines
surrounding Denmark „

ASSEMBLY GUIDE

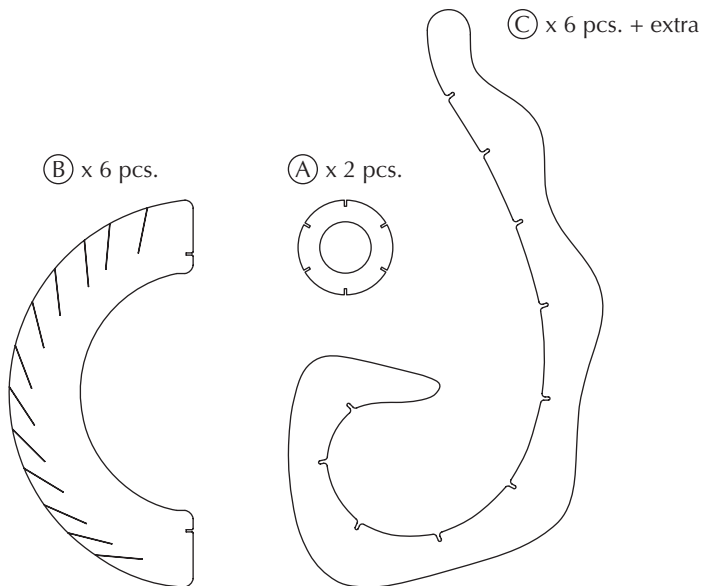

Find assembly video by
using the QR code



E27/E26

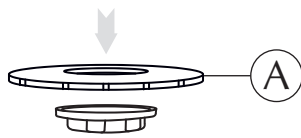

MAX 15W LED BULB

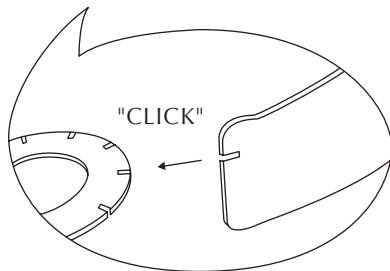
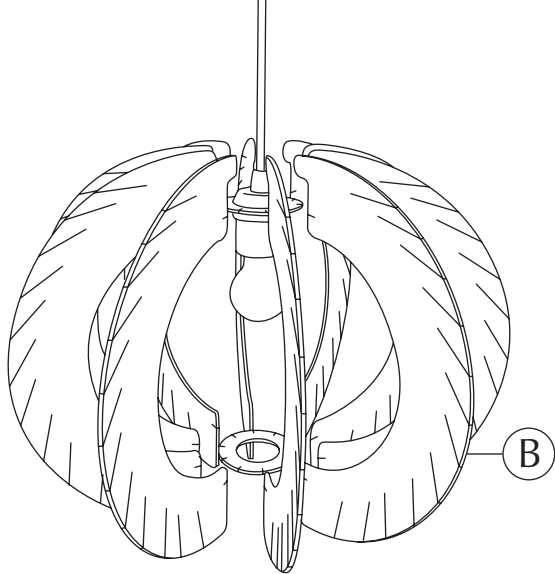

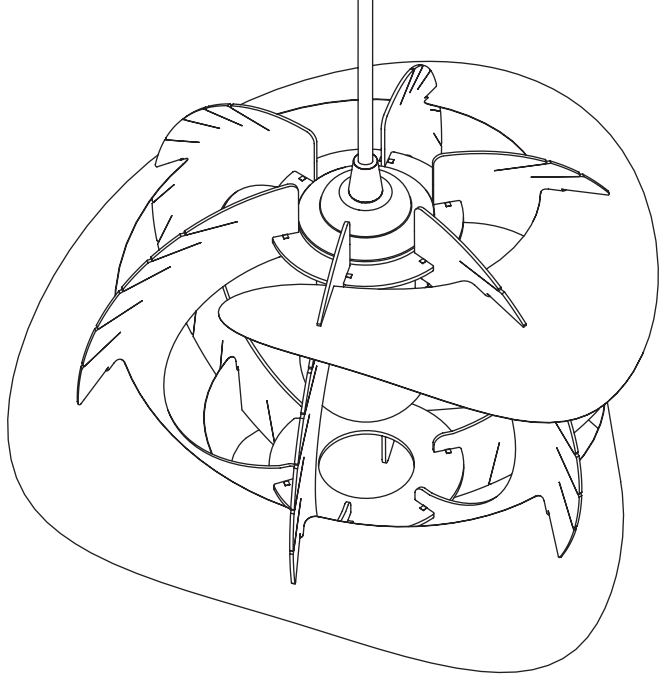

ONE RIGHT - ONE DOWN
WHITE VERSIONS CAN GO BOTH LEFT AND RIGHT

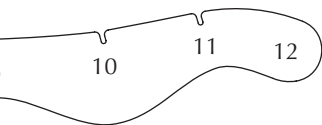
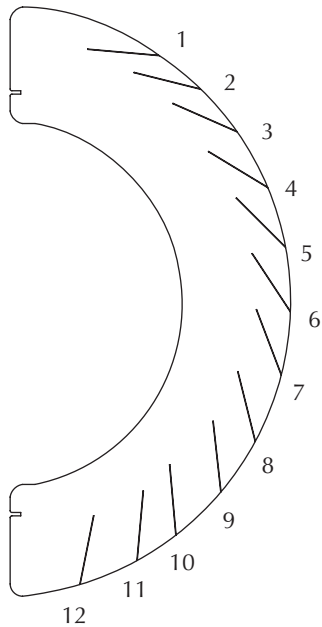
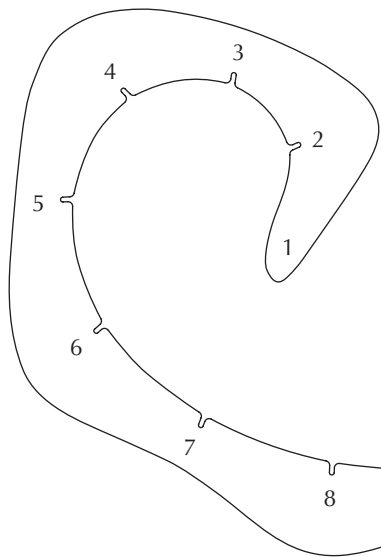

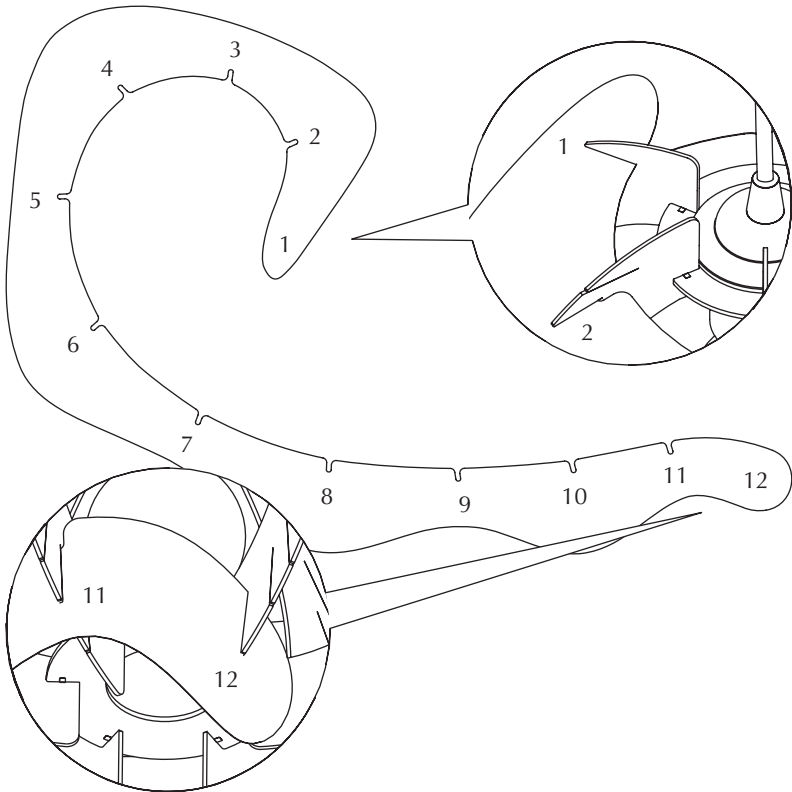

CARE AND MAINTENANCE

Please follow the below care and safety instructions to ensure many years of enjoyment with your new design item from UIMAGE.

- Clean the surface by wiping it with a dry cloth. Dirt can be removed with a damp cloth.
- Exposure to direct sunlight and high temperatures should be avoided as much as possible.

Keep these instructions at hand for future reference.

ENGLISH

Wash with soap before use to avoid attraction of dust.

DEUTSCH

Waschen Sie die Lampe vor Gebrauch mit Seife ab um Staubanziehung zu vermeiden.

FRANÇAIS

Laver au savon avant employ pour éviter que la poussière ne se dépose.

NEDERLANDS

Voor gebruik met zeep wassen om het aantrekken van stof te voorkomen.

DANSK

Vask med sæbe før brug for at undgå støvtiltrækning.

NORSK

Vask med såpe før bruk for a hindre tiltrekning av støv.

SUOMI

Pese saippualla ennen käyttöä vähentääksesi pölyn kerääntymistä.

SVENSKA

Tvätta med såpa före användning för att undvika att den drar till sig damm.

ESPAÑOL

Lavar con jabón antes de utilizar para que no atrape polvo.

ITALIANO

Onde evitare il deposito di polvere, lavare con acqua e sapone.

POLSKI

Przed użyciem umyć mydłem, aby uniknąć przyciągania kurzu.

PORTUGUÊS

Lavar com sabão antes de utilizar para evitar a atracção de pó.

РУССКИЙ

Для предотвращения попадания пыли перед использованием вымыть с мылом.

한국어

먼지가 묻지 않도록 사용 전에 비누로 닦아 주십시오

日本語

埃を吸引することを避けるため、使用開始前に石鹼で洗ってください

中文

为避免吸尘,使用前请在肥皂水里浸泡清洗.

SUSTAINABLE SUSTAINABILITY EFFORTS

We are dedicated being sensible frontrunners on the environmental responsibility. If we provide timeless and functional quality designs that last, we know nature will prevail, as will UIMAGE.

*"SAVING THE SCENT OF THE FOREST
AFTER AN EARLY MORNING RAIN"*

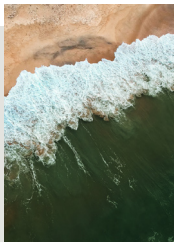

GIVING BACK TO NATURE

In collaboration with the NGO One Tree Planted, we are planting a tree every time one of our designs made from wood* are being sold.

* Includes: The Reader collection, A Conversation Piece collection, Stories collection, Treasures collection, Step It Up collection, Lounge Around collection, Audacious collection, Comfort Circle collection, Hang Out collection, My Spot collection, One More Look collection, Flow collection, Clava Wood collection, Forget Me Not collection, Chimes collection, Jazz collection

MULTIFUNCTION AND FLEXIBILITY

One of the key aspects of the designs at UIMAGE is multiple functions and flexibility. Designing with more than one function in mind is a sustainable mindset as it reduces the number of products you need to buy to get a complete setting for your space.



RECYCLING

Please follow the marked icons on the packaging materials for correct disposal of the remaining packaging materials:



CARDBOARD



PAPER



Recycle your waste correctly by searching for these icons on the packaging

FOLLOW US ON SOCIAL MEDIA



@umagedesign | #umagedesign | umage.com



231002

TRIPOD

base | user guide



UIMAGE



WITH LOVE FROM COPENHAGEN

At UIMAGE, our designers take inspiration from the distinct nature of the Nordic landscape to create unique designs related to the way we live in an urban setting. Influenced by the design language, colours and materials found around us in Scandinavia, we create a collection that is rooted in our home but designed for everyone.

Versatile, flexible and multifunctional, our designs are created to enhance an urban lifestyle in smaller spaces!

ENGLISH

If the external flexible cable or cord of this luminaire is damaged, it shall be exclusively replaced by the manufacturer or his service agent or a similar qualified person in order to avoid a hazard.

FRANÇAIS

Si le câble électrique de ce luminaire est endommagé, il peut être remplacé. Pour éviter tout danger, le remplacement doit impérativement être effectué par le fabricant, un représentant de celui-ci ou un réparateur agréé.

ESPAÑOL

Si se dañase el cable exterior flexible de esta lámpara, para evitar riesgos deberá ser sustituido exclusivamente por el fabricante, su representante o un electricista cualificado.

! IMPORTANT !

Tripod base safety instructions

(Read and keep these instructions for future reference)

PRODUCT NAME

Tripod base Model no.: 4055, 4056

Rating parameter: 120V, 60HZ, AC ONLY

Lamp type: E26 Type A / 60W MAX

NOTE

This instruction sheet covers a variety of stands (different colors), but with the same applications. Do not connect your stand to a power source until all stand- and lamp assembly and bulb installation is complete.

NOTICE

You are advised to contact a qualified electrician for these procedures

SAFETY PROCEDURES

Read and keep these instructions for future reference

- 1. Remove the packaging carefully without the use of sharp objects. Assemble the product as shown in this user guide, then place the product firmly on a fixed surface before moving onto next procedure.**
- 2. Unscrew the ring of the socket. Assemble the suitable lampshade (not included) and put it on the socket and screw the ring back on until lampshade is completely fastened.**
- 3. Firmly screw an E26 light bulb (MAX 60W) into the socket. Do NOT put your fingers into the socket!**

- 4. Insert the plug into a suitable outlet and turn on the power supply.**
- 5. Switch to on.**
- 6. Always disconnect the power supply before cleaning, changing of light bulbs or repair of the stand. The latter, should always be done by a qualified electrician.**
- 7. Let the light bulb cool off sufficiently before changing the bulb.**
- 8. Keep the Tripod away from any flammables, or objects that cannot handle heat.**
- 9. Please always place the stand on a level surface not more than 8° angle.**
- 10. The stand is for indoor use ONLY.**

- 11. If the stand in any way malfunctions, to avoid accidents or mishandling of the Tripod, please always contact a qualified electrician.**
- 12. Only use the Tripod, where these same official electrical- and technical parameters exist!**
- 13. Do NOT touch the light bulb immediately after the light is turned off. Be aware of possible scalding!**
- 14. The Tripod is NOT a childrens toy and should not be used in any other manner than described above.**
- 15. The minimum diameter of open area (top & bottom) should NOT be less than 100MM (4 inches); Lamp-to-shade spacing must be over 3-1/4 inches (63.5mm); Lamp Centerline Length must over 2-1/2 inches (82.5mm).**

- 16. The weight of lamp shade should NOT exceed 1.1 KGS (2-1/2LBS).**

NOTE

DO NOT try to repair the Tripod if the product, cable, socket or the lampshade is in any way broken or not as expected, such tasks are only intended for qualified electricians!



DESIGNED BY
SØREN RAVN CHRISTENSEN

“ Just where you need
to create that tranquil
flickering candlelight
atmosphere. ”

ASSEMBLY GUIDE

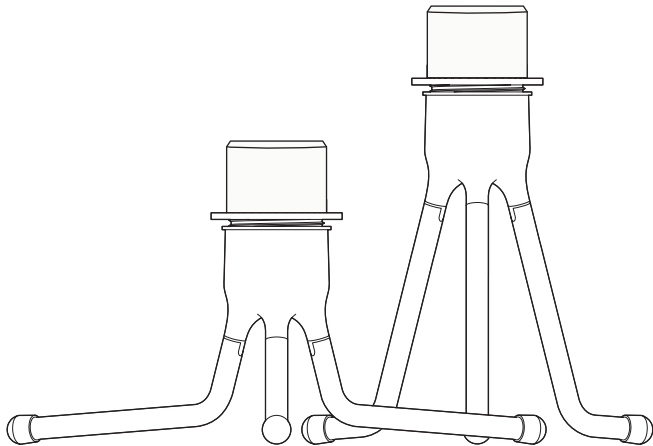

Find assembly videos by using the QR code or by
going online at our website
umage.com/instructions

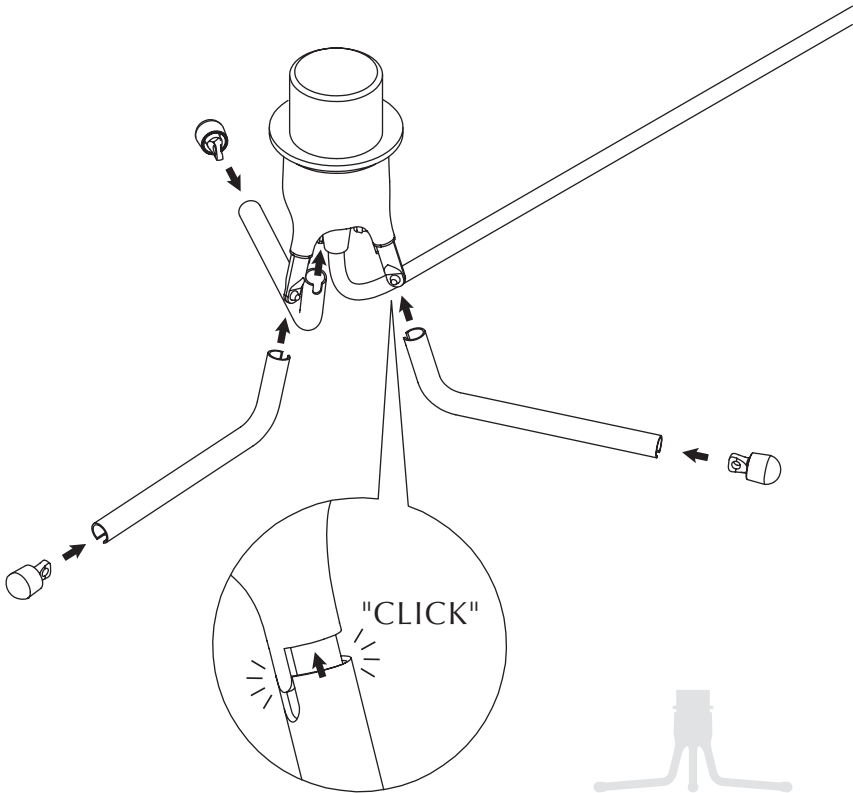

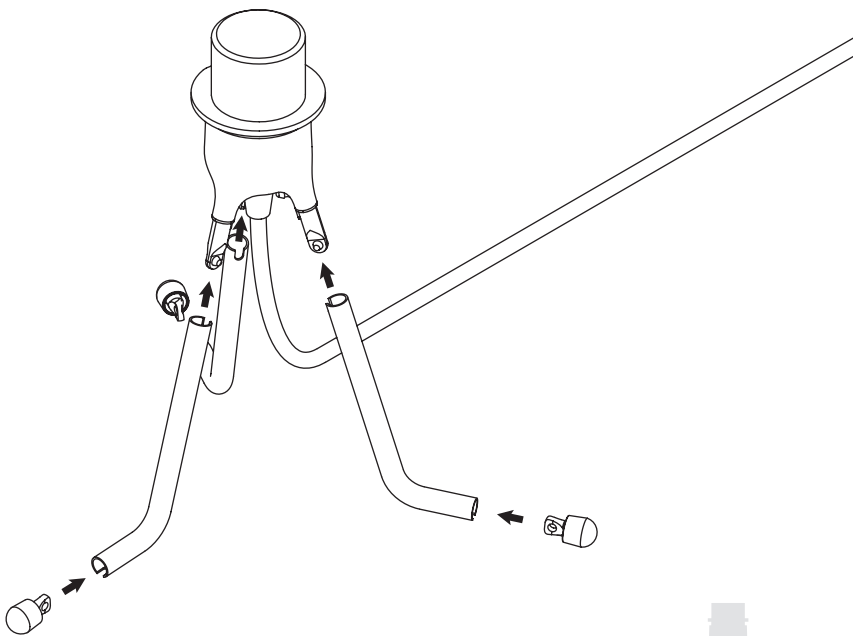

If the external flexible cable or cord of this luminaire is damaged, it shall be exclusively replaced by the manufacturer or a similar qualified person, in order to prevent any possible hazards.





MAX 60W



— >100 MM / >4" —

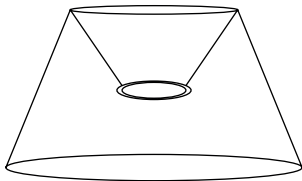

— >100 MM / >4" —

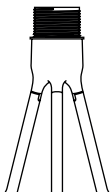



SUSTAINABLE SUSTAINABILITY EFFORTS

We are dedicated being sensible frontrunners on the environmental responsibility. If we provide timeless and functional quality designs that last, we know nature will prevail, as will UIMAGE.

*"SAVING THE SCENT OF THE FOREST
AFTER AN EARLY MORNING RAIN"*

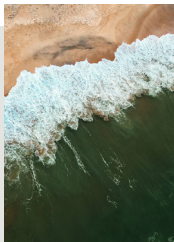

GIVING BACK TO NATURE

In collaboration with the NGO One Tree Planted, we are planting a tree every time one of our designs made from wood are being sold.

MULTIFUNCTION AND FLEXIBILITY

One of the key aspects of the designs at UIMAGE is multiple functions and flexibility. Designing with more than one function in mind is a sustainable mindset as it reduces the number of products you need to buy to get a complete setting for your space.



REUSABLE PACKAGING

To minimize packaging waste, most of the packaging from our lighting collection is repurposed to be used as beautiful storage boxes afterwards. Learn more on the next page...



REUSABLE PACKAGING

With your new lamp, you have also received a free decorative storage box for the shelf.

THIS IS HOW IT WORKS

When your new lamp is out of the box you can keep the box and reuse it as a storage box for your small bits and bobs and place it on the shelf or on the top of your closet - repurposing the packaging for you and the environment.

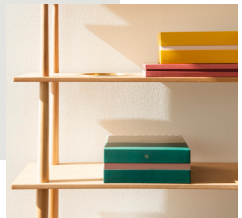

So not only are UIMAGE's designs flat-packed to optimize the global logistics and the environmental footprint, but it ensures that you don't need to throw away tons of packaging material, that can just as well be reused for something new.

Read more about our many sustainability efforts:
umage.com/sustainability



Please follow the marked icons on the packaging materials for correct disposal of the remaining packaging materials:



CARDBOARD



PAPER



Recycle your waste correctly
by searching for these icons on
the packaging

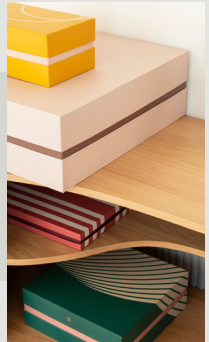

FOLLOW US ON SOCIAL MEDIA



@umagedesign | #umagedesign | umage.com



UMAGE



220523