

UPHORIA™ 3 LED PAR

LED PAR20, PAR30, PAR30LN & PAR38

The USHIO Uphoria™ 3 LED PAR lamps combine the classic styling of traditional PAR lamps with the advanced technology of LEDs and custom designed optics. This provides a lightweight, energy saving, LED lamp with the form, fit and function of a traditional halogen PAR lamp.

The dimmable Uphoria 3 LED PAR lamps are designed to replicate the shape and light output of halogen PAR lamps, but offer serious energy-saving benefits. These LED PAR lamps utilize tightly-binned, high color rendering LEDs and an advanced optical design with multi-faceted reflectors for superior beam control and reduced glare.

Uphoria 3 LED PAR lamps have a special thermal design that maintains proper thermal management of the LEDs. This maintains a quality light output while ensuring long life.

Ushio America is proud to stand behind these ENERGY STAR® certified LED lamps with a 3-year limited warranty. All Uphoria 3 LED PAR lamps operate on 120V with Soft White (2700K) and Warm White (3000K) color temperatures and a very high color rendering (90+). They are available in Narrow Flood and Flood beam angles in PAR20, PAR30 (SN & LN) and PAR38 lamp types.

FEATURES & BENEFITS:

- Very High Color Rendering (90+ CRI)
- Energy Saving
- Dimmable
- Direct Replacement for Halogen PAR Lamps
- Unique Optical Design for Improved Beam Photometry
- Damp Location Rated
- 25,000 Hours Rated Life
- Application Friendly: UV Free & IR Free
- Environmentally Friendly: Mercury Free, Lead Free & RoHS Compliant
- 3-Year Limited Warranty

Qualifications:



APPLICATIONS:

- Recessed Lighting
- Track Lighting
- Display Lighting
- Accent Lighting
- Art Gallery & Museum Lighting
- Office Lighting
- Hospitality Lighting

USHIO

UPHORIA™ 3 LED PAR, (90+ CRI)

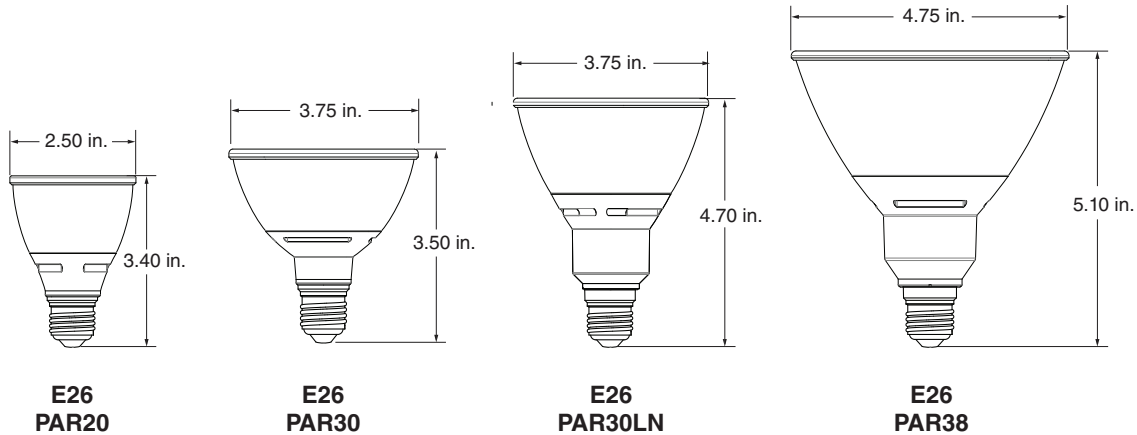

Watts (W)	Ordering Code	Lamp Description	Bulb Type	Volts (V)	Color Temp (K)	Beam Angle	Lumens* (lm)	CBCP* (cd)	CRI	Rated** Life (h)	Case Qty
7	1004075	★ 7W LED PAR20, FL40, SW27	PAR20	120	2700	40°	460	593	90+	25,000	12
7	1004076	★ 7W LED PAR20, FL40, WW30	PAR20	120	3000	40°	470	593	90+	25,000	12
7	1004077	★ 7W LED PAR20, NFL25, SW27	PAR20	120	2700	25°	460	1179	90+	25,000	12
7	1004078	★ 7W LED PAR20, NFL25, WW30	PAR20	120	3000	25°	470	1179	90+	25,000	12
11	1004079	★ 11W LED PAR30, FL40, SW27	PAR30	120	2700	40°	750	1315	90+	25,000	6
11	1004080	★ 11W LED PAR30, FL40, WW30	PAR30	120	3000	40°	800	1315	90+	25,000	6
11	1004081	★ 11W LED PAR30, NFL25, WW30	PAR30	120	3000	25°	800	2910	90+	25,000	6
11	1004082	★ 11W LED PAR30LN, FL40, SW27	PAR30LN	120	2700	40°	750	1315	90+	25,000	6
11	1004083	★ 11W LED PAR30LN, FL40, WW30	PAR30LN	120	3000	40°	800	1315	90+	25,000	6
11	1004084	★ 11W LED PAR30LN, NFL25, WW30	PAR30LN	120	3000	25°	800	2910	90+	25,000	6
15	1004085	★ 15W LED PAR38, NFL25, SW27	PAR38	120	2700	25°	950	4241	90+	25,000	6
17	1004086	★ 17W LED PAR38, FL40, SW27	PAR38	120	2700	40°	1150	2231	90+	25,000	6
17	1004087	★ 17W LED PAR38, FL40, WW30	PAR38	120	3000	40°	1200	2231	90+	25,000	6
17	1004088	★ 17W LED PAR38, NFL25, WW30	PAR38	120	3000	25°	1200	5382	90+	25,000	6

* Photometric data is based on LM-79 tests.

★ ENERGY STAR Certified

** Hours rated life based on 70% lumen maintenance. LM-80 data available.

Electrical Specifications:

Driver: High Efficiency

Power Factor: > 0.90

Dimming: See www.ushio.com for dimmer compatibility options.

UPHORIA™ 3 LED PAR, (90+ CRI)

Photometrics 2700K

Item 1004075			Item 1004077		
ø(ft)	H(ft)	E(fc)	ø(ft)	H(ft)	E(fc)
4.3	6.6	20.52	1.54	3.3	127.9
8.6	13.1	5.13	3.08	6.6	31.96
12.9	19.7	2.28	4.62	9.8	14.21
17.1	26.3	1.28	6.16	13.1	7.99
21.4	32.8	0.82	7.70	16.4	5.11
40°		7W	25°		7W
7W LED PAR20, FL40, SW27			7W LED PAR20, NFL25, SW27		

Item 1004079			Item 1004082			Item 1004085			Item 1004086		
ø(ft)	H(ft)	E(fc)	ø(ft)	H(ft)	E(fc)	ø(ft)	H(ft)	E(fc)	ø(ft)	H(ft)	E(fc)
2.2	3.3	133.1	2.1	3.3	136.7	2.8	6.6	108.8	2.1	3.3	225.8
4.4	6.6	33.29	4.3	6.6	34.17	5.6	13.1	27.20	4.2	6.6	56.44
6.6	9.8	14.79	6.4	9.8	15.19	8.4	19.8	12.09	6.3	9.8	25.08
8.8	13.1	8.32	8.7	13.1	8.54	11.2	26.3	6.80	8.5	13.1	14.11
11.1	16.4	5.33	10.8	16.4	5.47	14.0	32.8	4.35	10.6	16.4	9.03
40°		11W	40°		11W	25°		15W	40°		17W
11W LED PAR30, FL40, SW27			11W LED PAR30LN, FL40, SW27			15W LED PAR38, NFL25, SW27			17W LED PAR38, FL40, SW27		

Photometrics 3000K

Item 1004076			Item 1004078			Item 1004080			Item 1004081		
ø(ft)	H(ft)	E(fc)	ø(ft)	H(ft)	E(fc)	ø(ft)	H(ft)	E(fc)	ø(ft)	H(ft)	E(fc)
2.2	3.3	77.66	1.6	3.3	133.1	2.2	3.3	139.5	3.1	6.6	69.82
4.4	6.6	19.42	3.1	6.6	33.27	4.3	6.6	34.88	6.3	13.1	17.45
6.7	9.8	8.63	4.7	9.8	14.79	6.5	9.8	15.50	9.4	19.7	7.78
8.9	13.1	4.85	6.2	13.1	8.32	8.7	13.1	8.72	12.6	26.3	4.36
11.1	16.4	3.12	7.8	16.4	5.32	10.8	16.4	5.58	15.7	32.8	2.79
40°		7W	25°		7W	40°		11W	25°		11W
7W LED PAR20, FL40, WW30			7W LED PAR20, NFL25, WW30			11W LED PAR30, FL40, WW30			11W LED PAR30, NFL25, WW30		

Item 1004083			Item 1004084			Item 1004087			Item 1004088		
ø(ft)	H(ft)	E(fc)	ø(ft)	H(ft)	E(fc)	ø(ft)	H(ft)	E(fc)	ø(ft)	H(ft)	E(fc)
2.2	3.3	133.8	3.2	6.6	67.62	2.3	3.3	227.7	3.0	6.6	103.9
4.4	6.6	33.45	6.4	13.1	16.91	4.5	6.6	56.92	6.0	13.1	25.96
6.6	9.8	14.87	9.6	19.7	7.51	6.8	9.8	25.30	8.9	19.7	11.54
8.7	13.1	8.36	12.9	26.3	4.23	9.0	13.1	14.23	11.9	26.3	6.49
10.9	16.4	5.35	16.1	32.8	2.71	11.3	16.4	9.12	14.9	32.8	4.15
40°		11W	25°		11W	40°		17W	25°		17W
11W LED PAR30LN, FL40, WW30			11W LED PAR30LN, NFL25, WW30			17W LED PAR38, FL40, WW30			17W LED PAR38, NFL25, WW30		

UPHORIA™ 3 LED PAR, (90+ CRI)

Spectral Distribution Charts 2700K

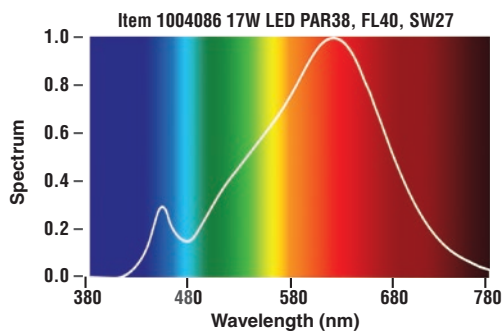
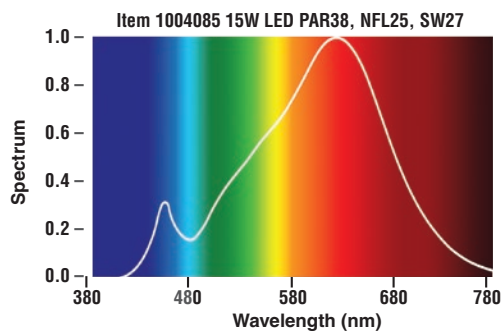
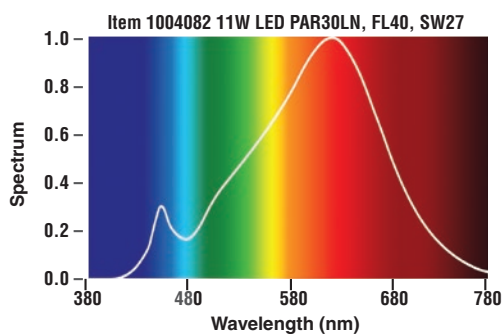
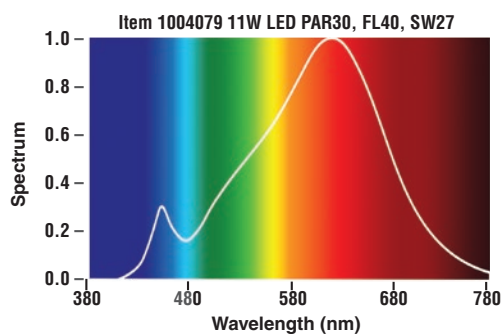
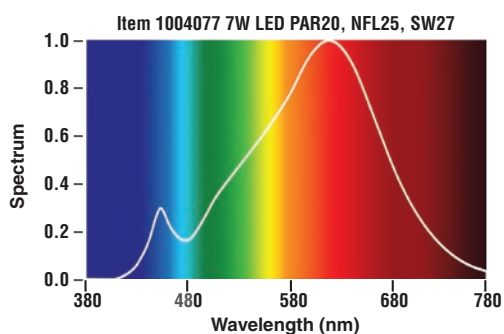
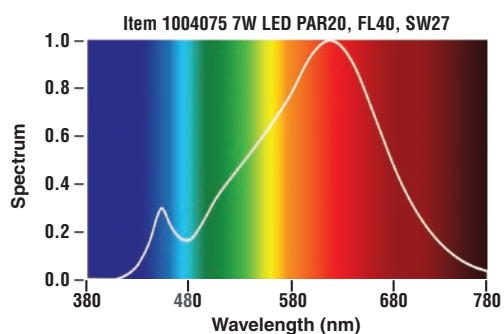

UPHORIA™ 3 LED PAR, (90+ CRI)

Spectral Distribution Charts 3000K

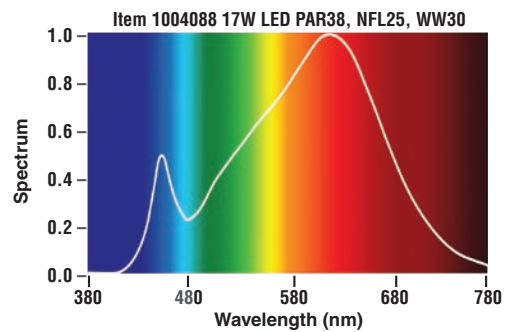
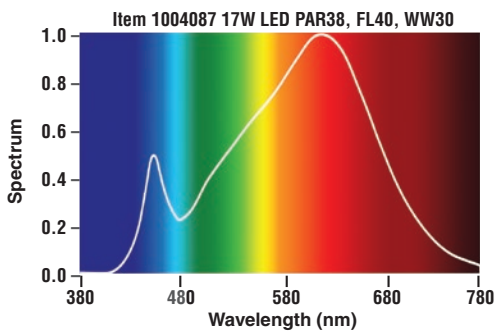
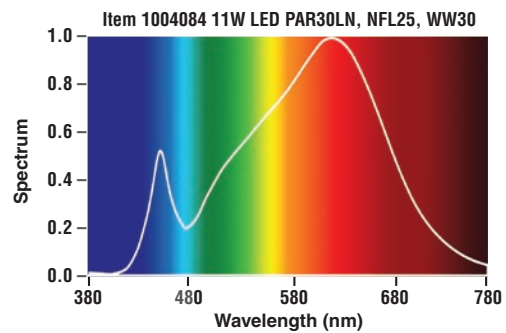
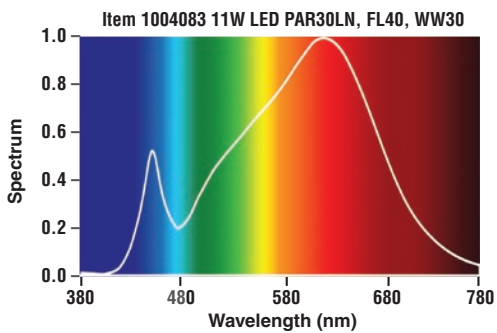
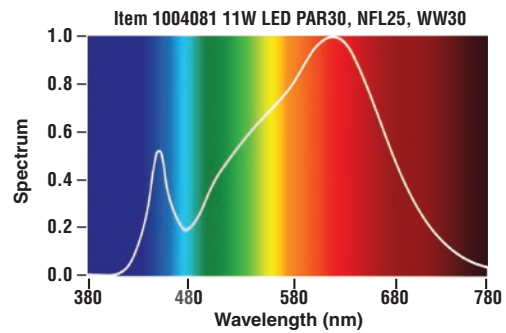
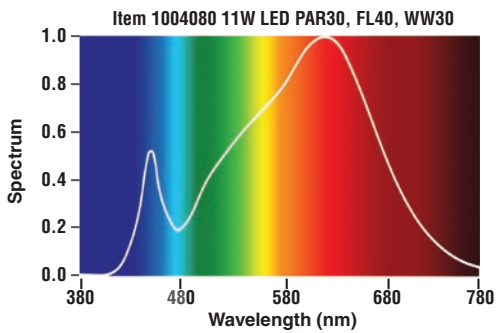
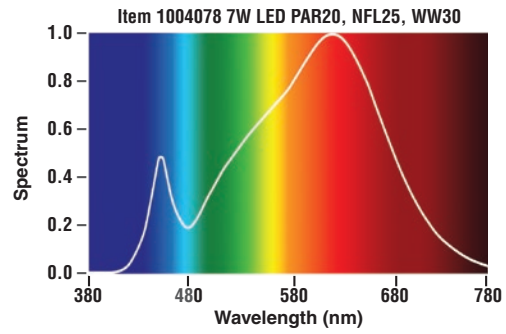
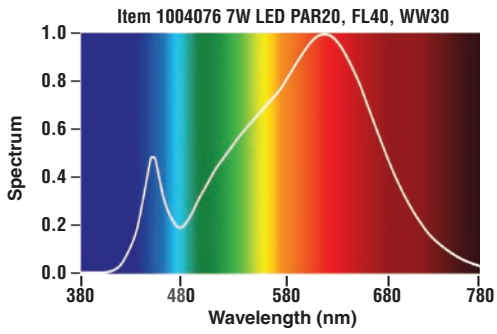

UPHORIA™ 3 LED PAR, (90+ CRI)

Lighting Facts 2700K

Item 1004075
7W LED PAR20, FL40, SW27

Lighting Facts/ Faits d'éclairage	
Per Bulb/Par l'ampoule	
Brightness/Luminosité	460 lumens
Estimated Yearly Energy Cost/ Coût énergétique annuel estimé	\$0.84
Based on 3 hrs/day, 11¢/kWh. Cost depends on rates and use. /Basé sur 3 heures/jour, 11¢/kWh. Les coûts dépendent du tarif et de la fréquence d'utilisation.	
Life/Vie	22 years/ans
Based on 3 hrs/day. /Basé sur 3 heures/jour.	
Light Appearance/Apparence de l'éclairage	
Warm/Chaud Cool/Froid	
2700K	
Energy Used/Énergie utilisée	7 watts

Item 1004077
7W LED PAR20, NFL25, SW27

Lighting Facts/ Faits d'éclairage	
Per Bulb/Par l'ampoule	
Brightness/Luminosité	460 lumens
Estimated Yearly Energy Cost/ Coût énergétique annuel estimé	\$0.84
Based on 3 hrs/day, 11¢/kWh. Cost depends on rates and use. /Basé sur 3 heures/jour, 11¢/kWh. Les coûts dépendent du tarif et de la fréquence d'utilisation.	
Life/Vie	22 years/ans
Based on 3 hrs/day. /Basé sur 3 heures/jour.	
Light Appearance/Apparence de l'éclairage	
Warm/Chaud Cool/Froid	
2700K	
Energy Used/Énergie utilisée	7 watts

Item 1004079
11W LED PAR30, FL40, SW27

Lighting Facts/ Faits d'éclairage	
Per Bulb/Par l'ampoule	
Brightness/Luminosité	750 lumens
Estimated Yearly Energy Cost/ Coût énergétique annuel estimé	\$1.32
Based on 3 hrs/day, 11¢/kWh. Cost depends on rates and use. /Basé sur 3 heures/jour, 11¢/kWh. Les coûts dépendent du tarif et de la fréquence d'utilisation.	
Life/Vie	22 years/ans
Based on 3 hrs/day. /Basé sur 3 heures/jour.	
Light Appearance/Apparence de l'éclairage	
Warm/Chaud Cool/Froid	
2700K	
Energy Used/Énergie utilisée	11 watts

Item 1004082
11W LED PAR30LN, FL40, SW27

Lighting Facts/ Faits d'éclairage	
Per Bulb/Par l'ampoule	
Brightness/Luminosité	750 lumens
Estimated Yearly Energy Cost/ Coût énergétique annuel estimé	\$1.32
Based on 3 hrs/day, 11¢/kWh. Cost depends on rates and use. /Basé sur 3 heures/jour, 11¢/kWh. Les coûts dépendent du tarif et de la fréquence d'utilisation.	
Life/Vie	22 years/ans
Based on 3 hrs/day. /Basé sur 3 heures/jour.	
Light Appearance/Apparence de l'éclairage	
Warm/Chaud Cool/Froid	
2700K	
Energy Used/Énergie utilisée	11 watts

Item 1004085
15W LED PAR38, NFL25, SW27

Lighting Facts/ Faits d'éclairage	
Per Bulb/Par l'ampoule	
Brightness/Luminosité	950 lumens
Estimated Yearly Energy Cost/ Coût énergétique annuel estimé	\$1.81
Based on 3 hrs/day, 11¢/kWh. Cost depends on rates and use. /Basé sur 3 heures/jour, 11¢/kWh. Les coûts dépendent du tarif et de la fréquence d'utilisation.	
Life/Vie	22 years/ans
Based on 3 hrs/day. /Basé sur 3 heures/jour.	
Light Appearance/Apparence de l'éclairage	
Warm/Chaud Cool/Froid	
2700K	
Energy Used/Énergie utilisée	15 watts

Item 1004086
17W LED PAR38, FL40, SW27

Lighting Facts/ Faits d'éclairage	
Per Bulb/Par l'ampoule	
Brightness/Luminosité	1150 lumens
Estimated Yearly Energy Cost/ Coût énergétique annuel estimé	\$2.05
Based on 3 hrs/day, 11¢/kWh. Cost depends on rates and use. /Basé sur 3 heures/jour, 11¢/kWh. Les coûts dépendent du tarif et de la fréquence d'utilisation.	
Life/Vie	22 years/ans
Based on 3 hrs/day. /Basé sur 3 heures/jour.	
Light Appearance/Apparence de l'éclairage	
Warm/Chaud Cool/Froid	
2700K	
Energy Used/Énergie utilisée	17 watts

Lighting Facts 3000K

Item 1004076
7W LED PAR20, FL40, WW30

Lighting Facts/ Faits d'éclairage	
Per Bulb/Par l'ampoule	
Brightness/Luminosité	470 lumens
Estimated Yearly Energy Cost/ Coût énergétique annuel estimé	\$0.84
Based on 3 hrs/day, 11¢/kWh. Cost depends on rates and use. /Basé sur 3 heures/jour, 11¢/kWh. Les coûts dépendent du tarif et de la fréquence d'utilisation.	
Life/Vie	22 years/ans
Based on 3 hrs/day. /Basé sur 3 heures/jour.	
Light Appearance/Apparence de l'éclairage	
Warm/Chaud	Cool/Froid
3000K	
Energy Used/Énergie utilisée	7 watts

Item 1004078
7W LED PAR20, NFL25, WW30

Lighting Facts/ Faits d'éclairage	
Per Bulb/Par l'ampoule	
Brightness/Luminosité	470 lumens
Estimated Yearly Energy Cost/ Coût énergétique annuel estimé	\$0.84
Based on 3 hrs/day, 11¢/kWh. Cost depends on rates and use. /Basé sur 3 heures/jour, 11¢/kWh. Les coûts dépendent du tarif et de la fréquence d'utilisation.	
Life/Vie	22 years/ans
Based on 3 hrs/day. /Basé sur 3 heures/jour.	
Light Appearance/Apparence de l'éclairage	
Warm/Chaud	Cool/Froid
3000K	
Energy Used/Énergie utilisée	7 watts

Item 1004080
11W LED PAR30, FL40, WW30

Lighting Facts/ Faits d'éclairage	
Per Bulb/Par l'ampoule	
Brightness/Luminosité	800 lumens
Estimated Yearly Energy Cost/ Coût énergétique annuel estimé	\$1.32
Based on 3 hrs/day, 11¢/kWh. Cost depends on rates and use. /Basé sur 3 heures/jour, 11¢/kWh. Les coûts dépendent du tarif et de la fréquence d'utilisation.	
Life/Vie	22 years/ans
Based on 3 hrs/day. /Basé sur 3 heures/jour.	
Light Appearance/Apparence de l'éclairage	
Warm/Chaud	Cool/Froid
3000K	
Energy Used/Énergie utilisée	11 watts

Item 1004081
11W LED PAR30, NFL25, WW30

Lighting Facts/ Faits d'éclairage	
Per Bulb/Par l'ampoule	
Brightness/Luminosité	800 lumens
Estimated Yearly Energy Cost/ Coût énergétique annuel estimé	\$1.32
Based on 3 hrs/day, 11¢/kWh. Cost depends on rates and use. /Basé sur 3 heures/jour, 11¢/kWh. Les coûts dépendent du tarif et de la fréquence d'utilisation..	
Life/Vie	22 years/ans
Based on 3 hrs/day. /Basé sur 3 heures/jour.	
Light Appearance/Apparence de l'éclairage	
Warm/Chaud	Cool/Froid
3000K	
Energy Used/Énergie utilisée	11 watts

Item 1004083
11W LED PAR30LN, FL40, WW30

Lighting Facts/ Faits d'éclairage	
Per Bulb/Par l'ampoule	
Brightness/Luminosité	800 lumens
Estimated Yearly Energy Cost/ Coût énergétique annuel estimé	\$1.32
Based on 3 hrs/day, 11¢/kWh. Cost depends on rates and use. /Basé sur 3 heures/jour, 11¢/kWh. Les coûts dépendent du tarif et de la fréquence d'utilisation.	
Life/Vie	22 years/ans
Based on 3 hrs/day. /Basé sur 3 heures/jour.	
Light Appearance/Apparence de l'éclairage	
Warm/Chaud	Cool/Froid
3000K	
Energy Used/Énergie utilisée	11 watts

Item 1004084
11W LED PAR30LN, NFL25, WW30

Lighting Facts/ Faits d'éclairage	
Per Bulb/Par l'ampoule	
Brightness/Luminosité	800 lumens
Estimated Yearly Energy Cost/ Coût énergétique annuel estimé	\$1.32
Based on 3 hrs/day, 11¢/kWh. Cost depends on rates and use. /Basé sur 3 heures/jour, 11¢/kWh. Les coûts dépendent du tarif et de la fréquence d'utilisation.	
Life/Vie	22 years/ans
Based on 3 hrs/day. /Basé sur 3 heures/jour.	
Light Appearance/Apparence de l'éclairage	
Warm/Chaud	Cool/Froid
3000K	
Energy Used/Énergie utilisée	11 watts

Item 1004087
17W LED PAR38, FL40, WW30

Lighting Facts/ Faits d'éclairage	
Per Bulb/Par l'ampoule	
Brightness/Luminosité	1200 lumens
Estimated Yearly Energy Cost/ Coût énergétique annuel estimé	\$2.05
Based on 3 hrs/day, 11¢/kWh. Cost depends on rates and use. /Basé sur 3 heures/jour, 11¢/kWh. Les coûts dépendent du tarif et de la fréquence d'utilisation.	
Life/Vie	22 years/ans
Based on 3 hrs/day. /Basé sur 3 heures/jour.	
Light Appearance/Apparence de l'éclairage	
Warm/Chaud	Cool/Froid
3000K	
Energy Used/Énergie utilisée	17 watts

Item 1004088
17W LED PAR38, NFL25, WW30

Lighting Facts/ Faits d'éclairage	
Per Bulb/Par l'ampoule	
Brightness/Luminosité	1200 lumens
Estimated Yearly Energy Cost/ Coût énergétique annuel estimé	\$2.05
Based on 3 hrs/day, 11¢/kWh. Cost depends on rates and use. /Basé sur 3 heures/jour, 11¢/kWh. Les coûts dépendent du tarif et de la fréquence d'utilisation.	
Life/Vie	22 years/ans
Based on 3 hrs/day. /Basé sur 3 heures/jour.	
Light Appearance/Apparence de l'éclairage	
Warm/Chaud	Cool/Froid
3000K	
Energy Used/Énergie utilisée	17 watts

CAUTIONS:

The lamp may not be compatible with all dimmers. Check www.ushio.com to find up to date dimmer compatibility options. Use only 120V 60Hz circuits. Do not open. No user serviceable parts inside. Use is not recommended where exposed to weather, outdoor usage requires an enclosed fixture. The device is not intended for use with emergency exit fixtures, emergency exit lights, photo controls or electric timers. Fully enclosed or recessed fixtures must contain proper ventilation. Reliable operating temperature is -4°F to 113°F. This device complies with Part 15 of the FCC Rules. Operation is subject to the following two conditions: (1) this device may not cause harmful interference, and (2) this device must accept any interference received, including interference that may cause undesired operation.