

ENTRA™ 3" LED

ADJUSTABLE DOWNLIGHT & WALL WASH

The ENTRA 3" Adjustable Downlight presents a cost-effective alternative for delivering architectural-grade aesthetics and quality, meeting budget-sensitive residential and commercial specifications. Custom-engineered for high performance and reliability, ENTRA 3" offers a complete feature set providing flexibility without overwhelming options. The ENTRA 3" Adjustable Downlight offers LED options with Static White and Warm Dim.

- SDCM: 2-step static white and warm dim
- Hot aiming (0-30° tilt + 359° rotation)
- Interchangeable optics: 20°, 40°, 65° (all included)
- Flanged/flangeless die-cast Bevel and Flat trims
- Available in IC Airtight, Chicago Plenum, and Fire-Rated

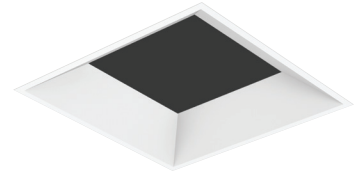

SHOWN IN FLANGELESS BEVEL SQUARE

LUMEN MULTIPLIER (CRI/CCT)

CCT	90 CRI MULTIPLIER
2700K	0.92
3000K	1.00
3500K	1.03
4000K	1.07

SPECIFICATIONS

	STATIC WHITE		WARM DIM	
	HIGH OUTPUT	LOW OUTPUT	HIGH	LOW
DELIVERED LUMENS	1165	856	981	721
WATTS	15	11	15	11
EFFICACY	78	78	66	66
CRI	90			
CBCP (AT 3000K)	20° - 4,213 40° - 2,327 65° - 1,244			
CCT	2700K, 3000K, 3500K, or 4000K		3000K - 1800K	
COLOR CONSISTENCY	2-step			
VOLTAGE	Universal 120V or 277V			
DIMMING ¹	Standard reverse-phase, forward-phase, TRIAC, and 0-10V dimming down to 1%			
POWER SUPPLY	Constant current driver with +.9 power factor and >87% efficiency			
OPTICS	20°, 40°, 65° (all included); accepts 2 optical media			
ADJUSTABILITY	0-30° tilt, 359° rotation			
CEILING APPEARANCE	Flanged or flangeless			
CEILING THICKNESS	Flanged or flangeless: 1/2" to 1.5"			
CEILING APERTURE	4" ceiling cutout			
HOUSING	Fire-Rated, IC Airtight, Chicago Plenum. IC suitable up to R60 spray foam insulation.			
CONSTRUCTION	Housing: Heavy-gauge, cold-rolled steel Trim: Die-cast aluminum			
FINISH	Housing: Black powder coat Trim: Black or White (paintable)			
GENERAL LISTINGS	ETL listed, Damp Location. Shower version Wet Listed.			
CALIFORNIA TITLE 24	Registered CEC Appliance Database. Can be used to comply with CEC 2019 Title 24 Part 6 (JA8-2016, JA8-2019).			
L70	50,000 hours min			
WARRANTY ²	5 years			

Data in chart reflect 3000K/90 CRI values unless noted.

Ordering grids available on page 2.

Accepts two optical controls and an optional trim-mounted lens.

¹See visualcomfort.com for dimmer compatibility.

²Visit visualcomfort.com for specific warranty limitations and details.

ENTRA™ 3" LED

ADJUSTABLE DOWNLIGHT & WALL WASH

ORDERING GRIDS

HOUSING

PRODUCT	LAMP	CRI	TEMPERATURE	BEAM	FUNCTION	HOUSING RATING
EN3R ENTRA 3" ROUND	-LH HIGH OUTPUT	9 90 CRI	27 2700K, 2-STEP STATIC WHITE	A 20° - 40° - 65° ²	A ADJUSTABLE ³	I IC AIRTIGHT C CHICAGO PLENUM F FIRE-RATED, IC AIRTIGHT ⁴
EN3S ENTRA 3" SQUARE	-LO LOW OUTPUT ¹	30 3000K, 2-STEP STATIC WHITE	35 3500K, 2-STEP STATIC WHITE			
		40 4000K, 2-STEP STATIC WHITE	WD WARM DIM (3000K-1800K), 2-STEP			
	-	9		A	A	

Includes an LED driver with universal input 120V-277V, dimmable by reverse-phase, forward-phase, TRIAC, or 0-10V controls. 277V is only compatible with 0-10V dimming. Housing ships with plaster plate for use on Flangeless installation. Do not use plate for flanged installs.

Trims are required and must be ordered separately.

¹LO - Sauna/steam-room use available only with combination of low output housing (-LO) and shower trim (-H or -S).

²A - LED module ships with 40° optic installed. Includes 20° and 65° optics as well.

³A - Use with 40° optic and adjust to 30° tilt for wall wash.

⁴F - Certified to ASTM E119, UL 263, and CAN/ULC-S101. Fire Rating of 1 and 2 hours, respectively. Fire-Rated, IC Airtight is available in LH high output only.

TRIM

PRODUCT	CEILING APPEARANCE	STYLE	APERTURE	FINISH
EN3R ENTRA 3" ROUND	L FLANGELESS	B BEVEL	-O NO LENS	B BLACK
EN3S ENTRA 3" SQUARE	L15 FLANGELESS 1" - 1.5" CEILING THICKNESS ¹	F FLAT	-S SHOWER (SOLITE LENS) ²	W WHITE (PAINTABLE)
	F FLANGED 0.5" - 0.75" CEILING THICKNESS	W WALL WASH ¹	-H SHOWER (SANDBLASTED LENS) ^{2,3}	
	F1 FLANGED 0.75" - 1" CEILING THICKNESS		-W WALL WASH (LENSED) ¹	
	F15 FLANGED 1" - 1.5" CEILING THICKNESS ¹			

¹W - Wall wash style trim can only be used with wall wash lensed aperture (-W). Wall wash not available with thicker ceiling trims (L15 and F15) as standard. Available through quotes as custom.

²H/S - Shower (Sandblasted or Solite) lens aperture requires bevel trim (B). Sauna/steam-room use available only with combination of low output housing (-LO) and shower trim (-H or -S). Shower lens includes a gasket.

³H - Sandblasted shower lens not available with thicker ceiling trims (L15 and F15). Not available with black trim (B).

LENSES/LOUVERS

PRODUCT ¹	
140MR16SF	SOLITE SOFT FOCUS LENS
140MR16SB	SANDBLASTED LENS
140MR16LL	LINEAR SPREAD LENS
140MR16DF	DIFFUSER SPREAD LENS
140MR16GL	CLEAR GLASS LENS
700A02-BK	EGGCRATE/HEXCELL LOUVER

¹For additional lenses, louvers, optical controls and accessories, reference visualcomfort.com. Lens/louvers mounted to lamp assembly only (max 2).

PLASTER PLATES

PRODUCT	
150EN3RPPLT	ROUND STANDARD PLASTER PLATE ¹
150EN3SPPLT	SQUARE STANDARD PLASTER PLATE ¹
150EN3RDCPPLT-B	ROUND DIE-CAST METAL PLASTER PLATE ²
150EN3SDCPPLT-B	SQUARE DIE-CAST METAL PLASTER PLATE ²

Plaster plates are used to convert flanged housings into flangeless housings.

¹Ships standard with all ENTRA 3" housings.

²Optional, durable die-cast design eliminates warping for a smooth, seamless appearance.

Counter-sunk screw holes simplify mudding and sanding. Integrated gunsights ensure optimal trim alignment.

REFLECTOR TRIMS

PRODUCT	
EN3TREFNS1	ROUND, BEVEL, FIXED
EN3TREFNS1	ROUND, FLAT, FIXED
EN3TREFNS2	SQUARE, BEVEL, FIXED
EN3TREFNS2	SQUARE, FLAT, FIXED
EN3TREFS1	ROUND, BEVEL, ADJUSTABLE
EN3TREFS2	ROUND, FLAT, ADJUSTABLE
EN3TREFS1	SQUARE, BEVEL, ADJUSTABLE

Square, flat, adjustable is not available.

Not for use with sloped ceilings.



ENTRA™ 3" LED

ADJUSTABLE DOWNLIGHT & WALL WASH

TRIMS

FLANGED

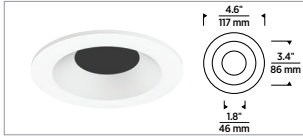

ROUND BEVEL

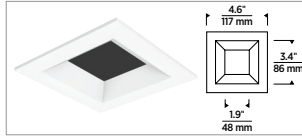

SQUARE BEVEL

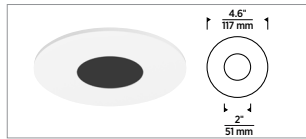

ROUND FLAT

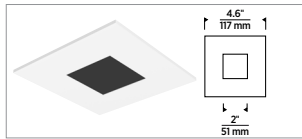

SQUARE FLAT

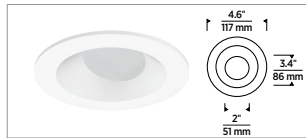

ROUND WALL WASH

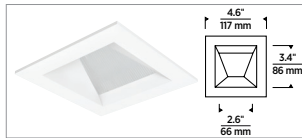

SQUARE WALL WASH

FLANGELESS

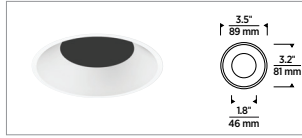

ROUND BEVEL

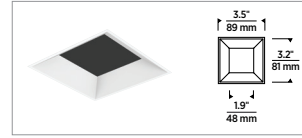

SQUARE BEVEL

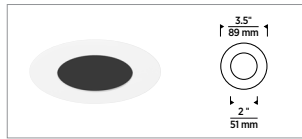

ROUND FLAT

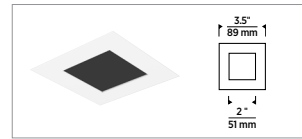

SQUARE FLAT



ROUND WALL WASH



SQUARE WALL WASH

FINISH



BLACK



WHITE (PAINTABLE)

HOUSING

HIGH OUTPUT

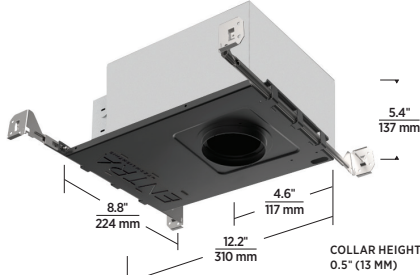

IC AIRTIGHT/FIRE-RATED CHICAGO PLENUM

LOW OUTPUT

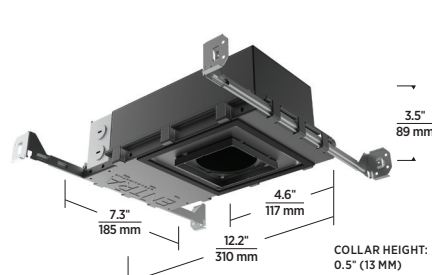

IC AIRTIGHT/CHICAGO PLENUM

ENTRA™ 3" LED

ADJUSTABLE DOWNLIGHT & WALL WASH

PLASTER PLATES

INCLUDED PLASTIC

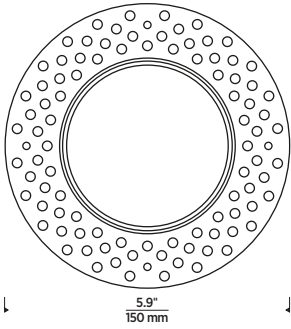

ROUND PLASTIC
(INCLUDED FOR FLANGELESS INSTALLATION)

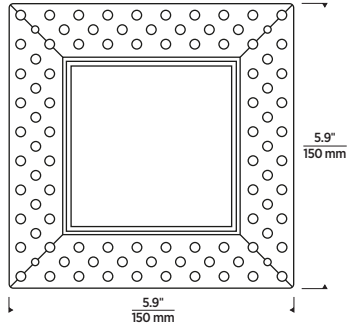

SQUARE PLASTIC
(INCLUDED FOR FLANGELESS INSTALLATION)

OPTIONAL DIE-CAST

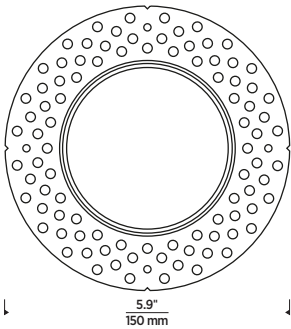

ROUND DIE-CAST

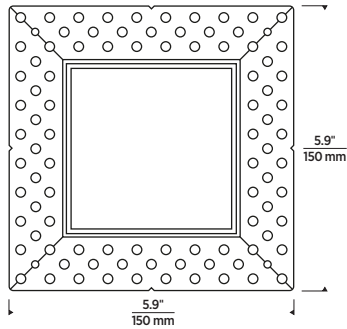

SQUARE DIE-CAST

ENTRA™ 3" LED

ADJUSTABLE DOWNLIGHT & WALL WASH

WALL WASH PERFORMANCE

2' FROM WALL

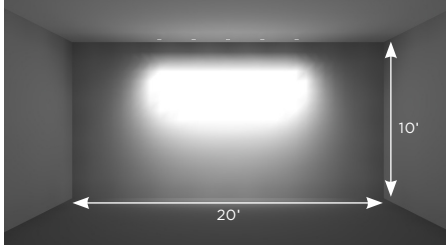

2' ON CENTER, 5 FIXTURES

2.5' FROM WALL

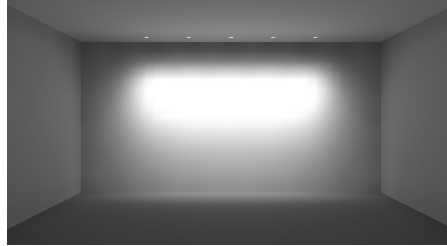

2.5' ON CENTER, 5 FIXTURES

3' FROM WALL

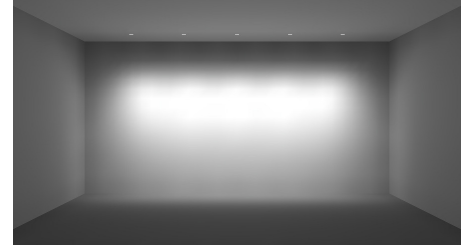

3' ON CENTER, 5 FIXTURES

FOOT-CANDLES ON WALL FROM MULTIPLE FIXTURES

HEIGHT ON WALL	2' FROM WALL					
	┌-2-┐ on center		┌-2.5-┐ on center		┌-3-┐ on center	
10'	0.4	0.8	0.4	0.5	0.8	0.5
9'	28.9	33.3	28.9	28.5	25.8	28.5
8'	63.1	71.6	63.1	63.5	54.1	63.5
7'	48.7	55.8	48.7	46.5	46.3	46.5
6'	29.9	32.7	29.9	27.7	28.5	27.7
5'	18.2	18.6	18.2	16.5	16.7	16.5
4'	10.9	10.7	10.9	10.0	9.9	10.0
3'	6.8	6.3	6.8	6.2	6.0	6.2
2'	4.5	3.9	4.5	4.1	3.8	4.1
1'	3.0	2.5	3.0	2.7	2.5	2.7

HEIGHT ON WALL	2.5' FROM WALL					
	┌-2-┐ on center		┌-2.5-┐ on center		┌-3-┐ on center	
10'	0.3	0.3	0.3	0.3	0.3	0.3
9'	10.3	12.9	10.3	9.4	11.5	9.4
8'	37.8	47.9	37.8	38.0	38.9	38.0
7'	45.0	54.0	45.0	42.6	45.8	42.6
6'	33.7	38.1	33.7	32.0	34.1	32.0
5'	23.0	24.2	23.0	21.5	22.2	21.5
4'	15.1	15.1	15.1	14.2	14.1	14.2
3'	9.8	9.4	9.8	9.2	9.0	9.2
2'	6.5	6.0	6.5	6.1	5.8	6.1
1'	4.5	4.0	4.5	4.2	3.9	4.2

HEIGHT ON WALL	3' FROM WALL					
	┌-2-┐ on center		┌-2.5-┐ on center		┌-3-┐ on center	
10'	0.2	0.2	0.2	0.2	0.2	0.2
9'	4.1	5.8	4.1	3.7	5.7	3.7
8'	21.2	27.6	21.2	20.5	23.6	20.5
7'	33.6	41.3	33.6	32.5	36.2	32.5
6'	33.0	38.1	33.0	31.6	34.7	31.6
5'	25.2	27.1	25.2	23.8	25.1	23.8
4'	18.1	18.3	18.1	17.0	17.2	17.0
3'	12.4	12.2	12.4	11.8	11.7	11.8
2'	8.6	8.2	8.6	8.1	7.9	8.1
1'	6.0	5.5	6.0	5.7	5.4	5.7



ENTRA™ 3" LED

ADJUSTABLE DOWNLIGHT & WALL WASH

PHOTOMETRICS

Description: ENTRA 3" LED
20° Beam, 0° Tilt
90 CRI, 3000K
High Output

Input Power (Watts): 14.7
Input Power Factor: 0.99
Absolute Luminous Flux (Lumens): 1081
Lumen Efficacy (Lumens per Watt): 73.5

Description: ENTRA 3" LED
40° Beam, 0° Tilt
90 CRI, 3000K
High Output

Input Power (Watts): 14.7
Input Power Factor: 0.99
Absolute Luminous Flux (Lumens): 1165
Lumen Efficacy (Lumens per Watt): 79.3

Description: ENTRA 3" LED
65° Beam, 0° Tilt
90 CRI, 3000K
High Output

Input Power (Watts): 14.7
Input Power Factor: 0.99
Absolute Luminous Flux (Lumens): 1142
Lumen Efficacy (Lumens per Watt): 77.7

ANGLE	0°	45°	90°
0°	4110	4110	4110
5°	3643	3217	3758
10°	2436	2229	2533
15°	1446	1393	1508
20°	845	817	846
25°	472	465	469
30°	242	253	252
35°	116	138	129
40°	59	77	64
45°	33	42	31
50°	19	23	17
55°	11	13	11
60°	6	7	6
65°	4	4	4
70°	3	3	3
75°	3	3	2
80°	2	2	1
85°	1	2	1
90°	1	1	1

ANGLE	0°	45°	90°
0°	2322	2322	2322
5°	2193	2232	2222
10°	1885	1940	1928
15°	1468	1497	1520
20°	1023	1038	1068
25°	648	664	675
30°	383	407	387
35°	218	244	210
40°	121	145	117
45°	66	83	62
50°	37	44	35
55°	21	24	20
60°	10	14	9
65°	4	7	3
70°	3	4	3
75°	2	2	2
80°	2	2	2
85°	1	1	1
90°	1	1	1

ANGLE	0°	45°	90°
0°	1237	1237	1237
5°	1220	1218	1212
10°	1146	1130	1120
15°	1025	1005	988
20°	872	849	833
25°	710	692	670
30°	543	534	507
35°	382	390	356
40°	246	262	239
45°	149	164	152
50°	85	96	92
55°	36	53	47
60°	12	26	18
65°	3	13	4
70°	3	4	3
75°	3	3	2
80°	2	2	2
85°	2	1	2
90°	2	1	1

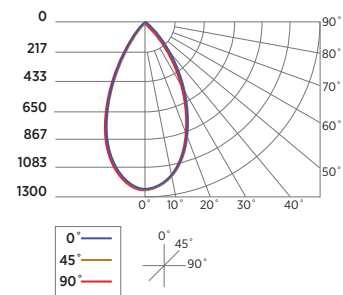
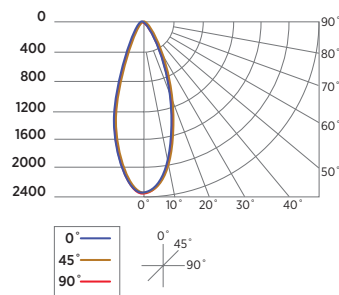
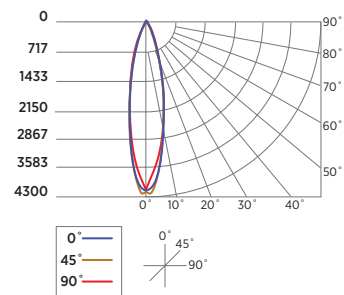
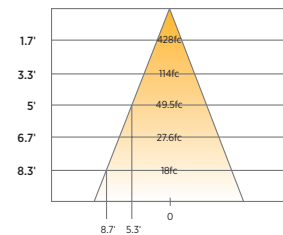
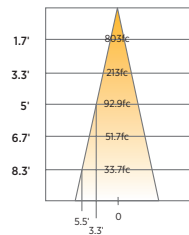
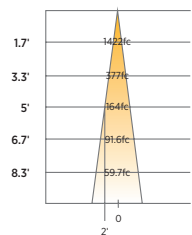

ENTRA™ 3" LED

ADJUSTABLE DOWNLIGHT & WALL WASH

PROJECT INFORMATION

JOB NAME AND INFORMATION

FIXTURE TYPE AND QUANTITY

NOTES
