

# INSTALLATION INSTRUCTION

## Cube Architectural - LED Wall Mount

DC-WS05, DC-WS06, DC-WD05, DC-WD06

# WAC LIGHTING

Responsible Lighting®

### WARNING

IMPORTANT: NEVER attempt any work without shutting off the electricity.

- Read all instructions before installing.
- System is intended for installation by a qualified electrician in accordance with the National Electrical Code and local regulations.
- Go to the main fuse box, or circuit breaker. Place the main power switch in the "OFF" position and unscrew the fuse(s) or switch "OFF" the circuit breaker switch(es) that control the power to the fixture or room that you are working on.
- Place the wall switch in the "OFF" position.

### CAUTION

- All parts must be used as indicated in these instructions. Do not substitute any parts, leave parts out, or use any parts that are worn out or broken. Failure to follow this instruction could invalidate the ETL/CETL listing of this fixture.  
CAUTION When handling the fixture, do not apply pressure to the LEDs. Hold the fixture by the base only.

### AVERTISSEMENT

IMPORTANT : Coupez l'électricité avant TOUTE manipulation.

- Lisez toutes les instructions avant d'installer.
- Système est destiné à être installé par un électricien qualifié en conformité avec le code national de l'électricité et les règlements locaux.
- Accédez au panneau central de disjoncteurs ou de fusibles de votre demeure et placez l'interrupteur principal en position d'arrêt (« OFF »).
- Placez l'interrupteur mural en position d'arrêt (« OFF »).

### MISE EN GARDE

- Toutes les pièces doivent être utilisées tel qu'il est indiqué dans ces instructions. Ne remplacez pas les pièces, n'en laissez pas de côté et ne les utilisez pas si elles sont usées ou brisées. Le non-respect de ces instructions peut annuler l'homologation ETL/CETL du luminaire. MISE EN GARDE Ors de la manipulation de l'appareil, ne pas appliquer de pression à la LED, tenir l'appareil par la seule base.

### ADVERTENCIA

IMPORTANTE: NUNCA intente hacer trabajos sin desconectar el suministro eléctrico.

- Lea y comprenda todas las instrucciones e ilustraciones por completo antes de proceder con el ensamblaje e instalación de esta lámpara.
- Sistema está diseñado para ser instalado por un electricista calificado, de acuerdo con el código eléctrico nacional y las normas locales.
- Diríjase a la caja de fusibles o a la caja del interruptor de circuito principal en su hogar. Coloque el interruptor de alimentación principal en la posición "OFF" (APAGADO).
- Coloque el interruptor de la pared en la posición "OFF" (APAGADO).

### PRECAUCIÓN

- Todas las piezas deben usarse como lo indican estas instrucciones. No reemplace las piezas, no omita piezas durante la instalación ni utilice piezas gastadas o rotas. El incumplimiento de esta indicación podría invalidar la calificación ETL/CETL esta lámpara. PRECAUCIÓN Al manipular el aparato, no aplique presión a los LED, mantenga el aparato en la base sólo.

## HARDWARE

### FIG.1

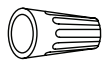

Wire Connector  
Qty: 5pcs  
7EAC112201



Junction Box Screw  
Qty: 3pcs  
7MPF0825F1



Gasket

Qty: 2pcs (5")      Qty: 2pcs (6")  
WT: 7TGD070101WT      WT: 7TGD080101WT  
BK: 7TGD070101BK      BK: 7TGD080101BK  
BZ: 7TGD070101BZ      BZ: 7TGD080101BZ  
GH: 7TGD070101GH      GH: 7TGD080101GH

wacighting.com  
Phone (800) 526.2588  
Fax (800) 526.2585

Headquarters/Eastern Distribution Center  
44 Harbor Park Drive  
Port Washington, NY 11050

Central Distribution Center  
1600 Distribution Ct  
Lithia Springs, GA 30122

Western Distribution Center  
1750 Archibald Avenue  
Ontario, CA 91760

# INSTALLATION INSTRUCTION

## Cube Architectural - LED Wall Mount

DC-WS05, DC-WS06, DC-WD05, DC-WD06

# WAC LIGHTING

Responsible Lighting®

### OVERVIEW

It is surface mount down light, included ceiling mount, pendant mount, single direction wall wash and up-down direction wall wash. Check catalog for various mount type, size, beam angle and color choices.

### FIXTURE INSTALLATION

1. Carefully unpack your new fixture and lay out all the parts on a clear area. Be carefully not to lose any small parts necessary for installation. (See **FIG.1**)
2. Remove the screw holding mounting plate to fixture, and remove mounting plate from fixture. (See **FIG.2**)
3. Secure mounting plate to the junction box in wall provided by others. (See **FIG.2**)
4. Pull power supply wires out of junction box through mounting plate. Connect black fixture wire to hot wire, white fixture wire to neutral wire and green fixture wire to ground. This fixture offers 0-10V dimming capability. To utilize, connect purple fixture wire to hot dimming wire and gray fixture wire to neutral dimming wire. If not utilizing dimming, terminate the dimming wires by capping them separately. After wires are connected securely, tuck them carefully inside the junction box. (See **FIG.2**)
5. Put the fixture to the mounting plate, and secure with screws and gasket. (See **FIG.2**)

**FIG.2**

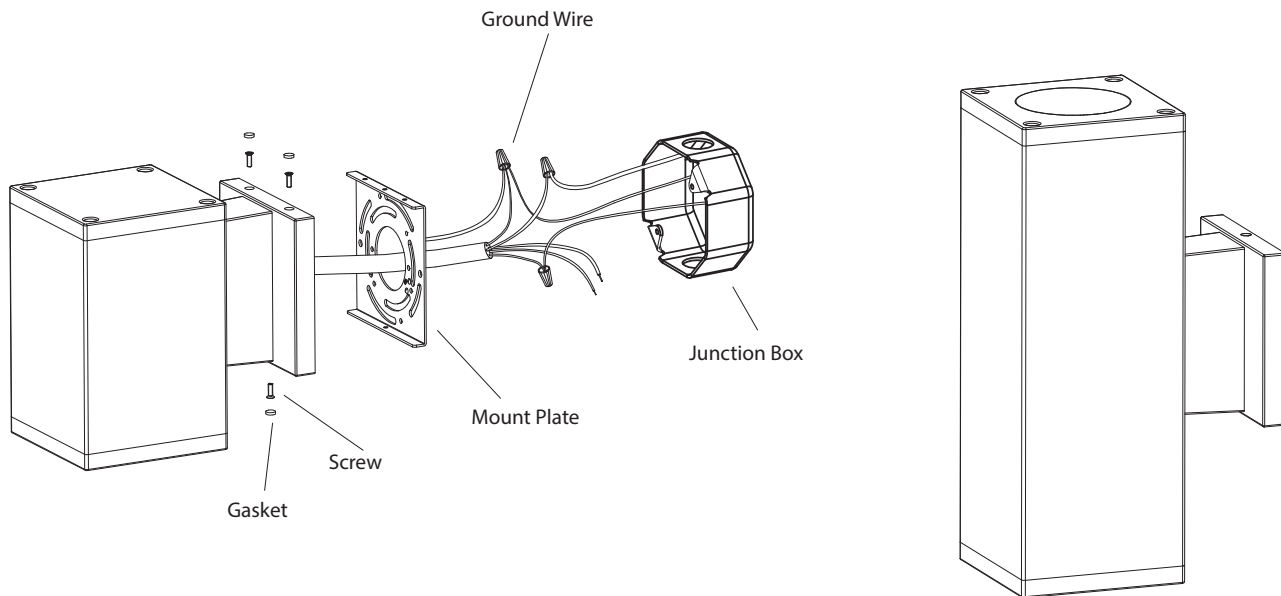

wacighting.com  
Phone (800) 526.2588  
Fax (800) 526.2585

Headquarters/Eastern Distribution Center  
44 Harbor Park Drive  
Port Washington, NY 11050

Central Distribution Center  
1600 Distribution Ct  
Lithia Springs, GA 30122

Western Distribution Center  
1750 Archibald Avenue  
Ontario, CA 91760

# INSTALLATION INSTRUCTION

## Cube Architectural - LED Wall Mount

DC-WS05, DC-WS06, DC-WD05, DC-WD06

# WAC LIGHTING

Responsible Lighting®

### REFLECTOR REPLACEMENT

1. Remove panel assembly by loosening the fixture screw and gasket, remove four chips to change reflector. (FIG.3)
2. Replace your beam angle reflector on panel and fix the clips. (FIG.4)

**FIG.3** Remove four clips

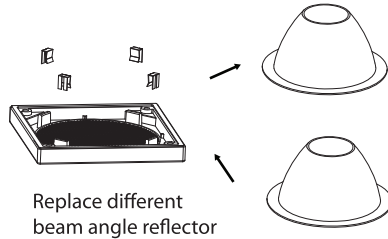

**FIG.4**

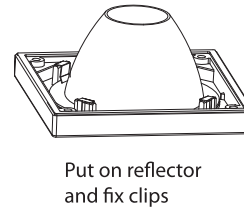

### LED REPLACEMENT

1. Loosen the screw and gasket (See FIG.5), remove the panel assembly (See FIG.6).
2. Loosen the LED screws and LED holder, carefully disconnect LED quick connector then replace LED. (See FIG.7).

**FIG.5** Loosen the fixture screws and gaskets



**FIG.6** Remove panel assembly

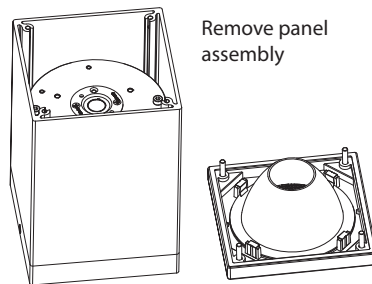

**FIG.7** LED holder, Screws, Connector, LED

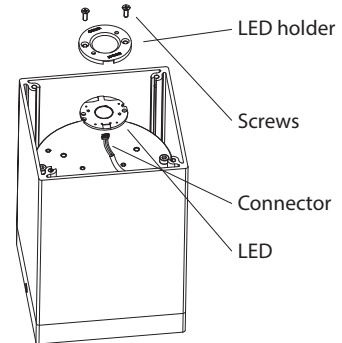

### DRIVER REPLACEMENT

1. Loosen the screw and gasket (See FIG.8), remove the cover assembly (See FIG.9).
2. Loosen the LED driver screws, carefully disconnect LED driver connector from LED connector and replace driver by removing driver mounting screws. (See FIG.10).

**FIG.8** Loosen the fixture screws and gaskets

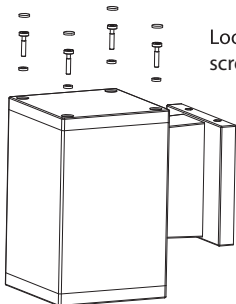

**FIG.9** Remove panel assembly

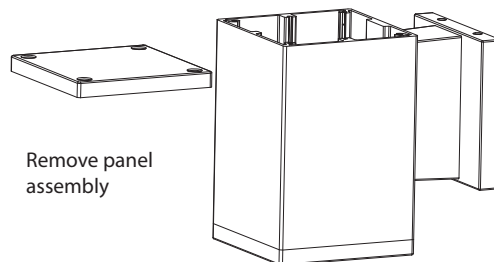

**FIG.10** LED holder

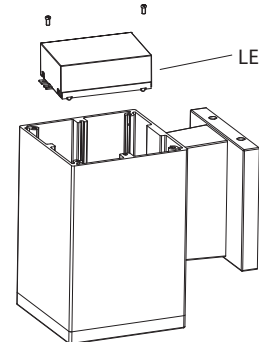

### COMPLETING THE INSTALLATION

To prevent moisture from entering the outlet box and causing a short, use clear caulking (i.e. indoor/outdoor silicone sealant) to outline the outside of fixture plate where it meets the wall leaving a space at bottom to allow moisture a means to escape.

wacighting.com  
Phone (800) 526.2588  
Fax (800) 526.2585

Headquarters/Eastern Distribution Center  
44 Harbor Park Drive  
Port Washington, NY 11050

Central Distribution Center  
1600 Distribution Ct  
Lithia Springs, GA 30122

Western Distribution Center  
1750 Archibald Avenue  
Ontario, CA 91760

# INSTALLATION INSTRUCTION

## Cube Architectural - LED Wall Mount

DC-WE05, DC-WE06

# WAC LIGHTING

Responsible Lighting®

### WARNING

IMPORTANT: NEVER attempt any work without shutting off the electricity.

- Read all instructions before installing.
- System is intended for installation by a qualified electrician in accordance with the National Electrical Code and local regulations.
- Go to the main fuse box, or circuit breaker. Place the main power switch in the "OFF" position and unscrew the fuse(s) or switch "OFF" the circuit breaker switch(es) that control the power to the fixture or room that you are working on.
- Place the wall switch in the "OFF" position.

### CAUTION

- All parts must be used as indicated in these instructions. Do not substitute any parts, leave parts out, or use any parts that are worn out or broken. Failure to follow this instruction could invalidate the UL/CUL listing of this fixture.  
CAUTION When handling the fixture, do not apply pressure to the LEDs. Hold the fixture by the base only.

### AVERTISSEMENT

IMPORTANT : Coupez l'électricité avant TOUTE manipulation.

- Lisez toutes les instructions avant d'installer.
- Système est destiné à être installé par un électricien qualifié en conformité avec le code national de l'électricité et les règlements locaux.
- Accédez au panneau central de disjoncteurs ou de fusibles de votre demeure et placez l'interrupteur principal en position d'arrêt (« OFF »).
- Placez l'interrupteur mural en position d'arrêt (« OFF »).

### MISE EN GARDE

- Toutes les pièces doivent être utilisées tel qu'il est indiqué dans ces instructions. Ne remplacez pas les pièces, n'en laissez pas de côté et ne les utilisez pas si elles sont usées ou brisées. Le non-respect de ces instructions peut annuler l'homologation UL/CUL du luminaire. MISE EN GARDE Lors de la manipulation de l'appareil, ne pas appliquer de pression à la LED, tenir l'appareil par la seule base.

### ADVERTENCIA

IMPORTANTE: NUNCA intente hacer trabajos sin desconectar el suministro eléctrico.

- Lea y comprenda todas las instrucciones e ilustraciones por completo antes de proceder con el ensamblaje e instalación de esta lámpara.
- Sistema está diseñado para ser instalado por un electricista calificado, de acuerdo con el código eléctrico nacional y las normas locales.
- Diríjase a la caja de fusibles o a la caja del interruptor de circuito principal en su hogar. Coloque el interruptor de alimentación principal en la posición "OFF" (APAGADO).
- Coloque el interruptor de la pared en la posición "OFF" (APAGADO).

### PRECAUCIÓN

- Todas las piezas deben usarse como lo indican estas instrucciones. No reemplace las piezas, no omita piezas durante la instalación ni utilice piezas gastadas o rotas. El incumplimiento de esta indicación podría invalidar la calificación UL/CUL esta lámpara. PRECAUCIÓN Al manipular el aparato, no aplique presión a los LED, mantenga el aparato en la base sólo.

### HARDWARE

FIG.1



Wire Connector  
Qty: 5pcs  
7EAC112201



Junction Box Screw  
Qty: 3pcs  
7MPF0825F1



Gasket

Qty: 2pcs (5")      Qty: 2pcs (6")  
WT: 7TGD070101WT      WT: 7TGD080101WT  
BK: 7TGD070101BK      BK: 7TGD080101BK  
BZ: 7TGD070101BZ      BZ: 7TGD080101BZ  
GH: 7TGD070101GH      GH: 7TGD080101GH

wacighting.com  
Phone (800) 526.2588  
Fax (800) 526.2585

Headquarters/Eastern Distribution Center  
44 Harbor Park Drive  
Port Washington, NY 11050

Central Distribution Center  
1600 Distribution Ct  
Lithia Springs, GA 30122

Western Distribution Center  
1750 Archibald Avenue  
Ontario, CA 91760

**OVERVIEW**

It is wall mount down light. Check catalog for various size, beam angle and color choices.

**FIXTURE INSTALLATION**

1. Carefully unpack your new fixture and lay out all the parts on a clear area. Be carefully not to lose any small parts necessary for installation. (See **FIG.1**)
2. Remove the screw holding mounting plate to fixture, and remove mounting plate from fixture. (See **FIG.2**)
3. Secure mounting plate to the junction box in wall provided by others. (See **FIG.2**)
4. Pull power supply wires out of junction box through mounting plate. Connect black fixture wire to hot wire, white fixture wire to neutral wire and green fixture wire to ground. This fixture offers 0-10V dimming capability. To utilize, connect purple fixture wire to hot dimming wire and gray fixture wire to neutral dimming wire. If not utilizing dimming, terminate the dimming wires by capping them separately. After wires are connected securely, tack them carefully inside the junction box . (See **FIG.2**)
5. Put the fixture to the mounting plate, and secure with screws and gasket.(See **FIG.2**)

**FIG.2**

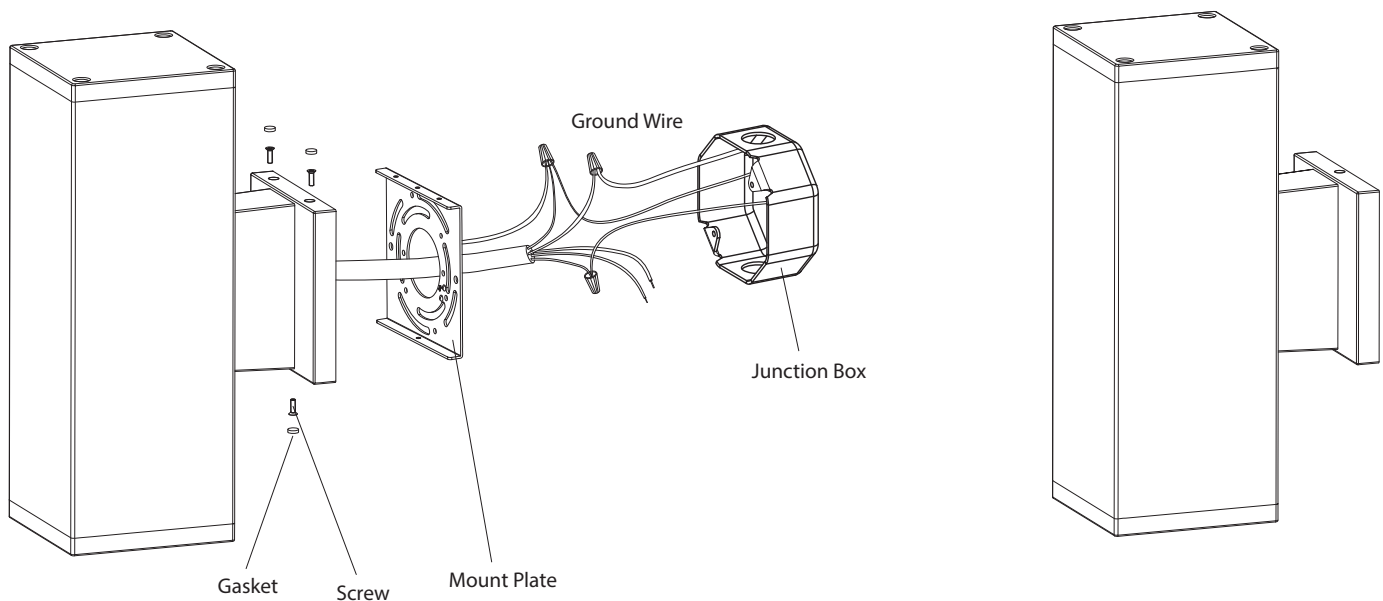

**REFLECTOR REPLACEMENT**

1. Remove panel assembly by loosening the fixture screw and gasket, remove four clips to change reflector. (FIG.3)
2. Replace your beam angle reflector on panel and fix the clips. (FIG.4)

**FIG.3** Remove four clips

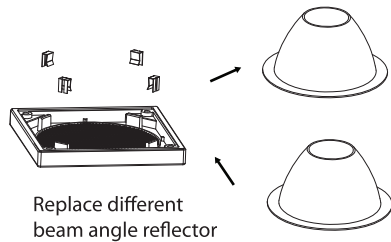

**FIG.4**

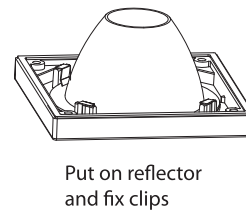

**LED REPLACEMENT**

1. Loosen the screw and gasket (See FIG.5), remove the panel assembly (See FIG.6).
2. Loosen the LED screws and LED holder, carefully disconnect LED quick connector then replace LED. (See FIG.7).

**FIG.5** Loosen the fixture screws and gaskets

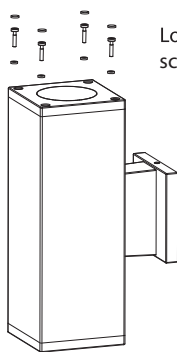

**FIG.6** Remove panel assembly

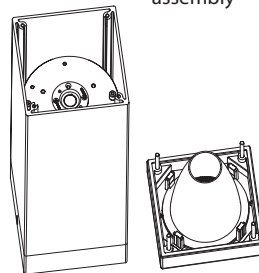

**FIG.7** Screws, LED holder, LED, Connector

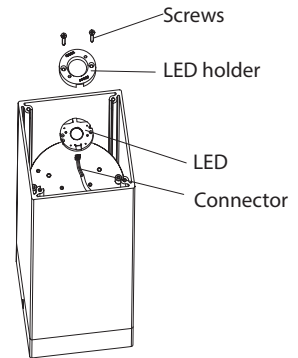

**DRIVER REPLACEMENT**

1. Loosen the screw and gasket (See FIG.8), remove the cover assembly (See FIG.9).
2. Loosen the LED driver screws, carefully disconnect LED driver connector from LED connector and replace driver by removing driver mounting screws. (See FIG.10).

**FIG.8** Loosen the fixture screws and gaskets

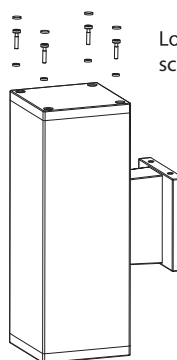

**FIG.9** Remove panel assembly

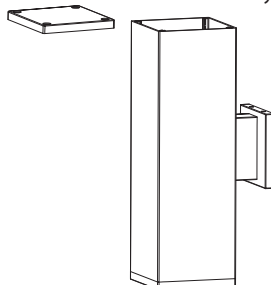

**FIG.10** LED Driver

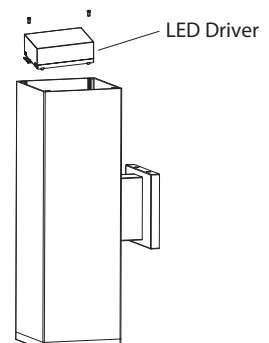

**COMPLETING THE INSTALLATION**

To prevent moisture from entering the outlet box and causing a short, use clear caulking (i.e. indoor/outdoor silicone sealant) to outline the outside of fixture plate where it meets the wall leaving a space at bottom to allow moisture a means to escape.