

Lightology

lightology.com
866-954-4489
06-04-26

Project: _____

Company: _____

Location: _____ Fixture Type: _____

SPEC #: **CER104429**

Approved On: _____ Approved By: _____

Aeris Linear Pendant By Cerno



Description

The Aeris Linear Pendant features organic and often wild swirls of walnut grains and the addition of rigorous slits and inlays that allow the light within to give of a beautiful and rich glow that creates a juxtaposition between the light and components of the fixture. Available in two sizes with a Brushed Aluminum or Black Anodized finish complemented by an Oiled Walnut or Dark Stained Walnut shade. 2700K and 3500K color temperature options available. Suitable for sloped ceilings. UL listed. Made in USA.



Shown in brushed aluminum / dark stained walnut

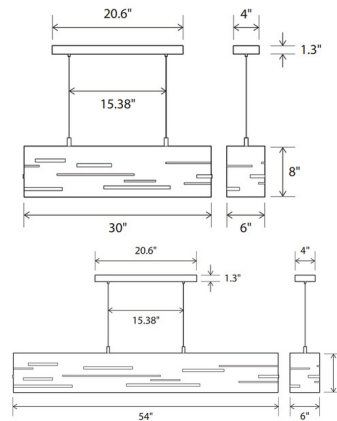

Specifications

COLOR	Dark Stained Walnut
BODY FINISH	Black Anodized
WATTAGE	16W
DIMMER	Low Voltage Electronic
DIMENSIONS	54"W x 8"H x 6"D
INTEGRATED LED MODULE	1 x LED/16W/120-277V LED
COUNTRY OF ORIGIN	United States

Technical Information

COLOR RENDERING	90 CRI
LAMP COLOR	2700K
LUMENS/WATT	107.50
LUMINOUS FLUX	1720 lumens



CLICK TO VIEW PRODUCT

Notes: