

Lightology

lightology.com
866-954-4489
05-22-26

Project: _____
Company: _____
Location: _____ Fixture Type: _____
SPEC #: **JUN111321**
Approved On: _____ Approved By: _____

MAGXFMR 60W Magnetic Remote Transformer 12V By Juno Lighting



Description

60 Watt 12V Class 2 Remote Magnetic Transformer is rated for 60 watts total load. 120VAC input. Thermally protected primary. Resettable magnetic circuit breaker. Provides faster short circuit protection than standard thermal circuit breakers. Provides overload protection which is unaffected by ambient operating conditions. Enables transformer to be mounted in any position. 120 volt installations only. Incandescent loads can be dimmed with high quality dimmers designed specifically for use with magnetic transformer. LED loads may be dimmed using dimmers that have been tested and qualified by Juno for use with Juno LED fixtures. Ideally suited for driving Juno Mini LED Gimbal, Downlight and Solo Task fixtures. May also be used to operated other low wattage LED or incandescent loads. Suitable for remote mounting at long distances. Available in a 10 watt, 25 watt and 60 watt version. UL listed.



Shown in black

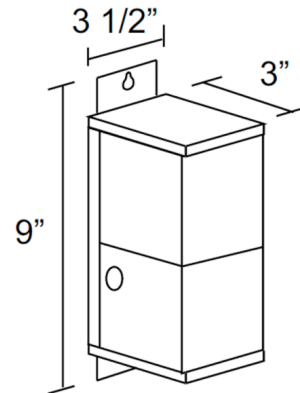

Specifications

COLOR	N/A
BODY FINISH	Black
WATTAGE	60W
DIMMER	Low Voltage Magnetic
DIMENSIONS	3.5"W x 9"H x 3"D
BULB NOT INCLUDED	N/A



CLICK TO VIEW PRODUCT

Notes: