

# Lightology

lightology.com  
866-954-4489  
05-24-26

Project: \_\_\_\_\_

Company: \_\_\_\_\_

Location: \_\_\_\_\_ Fixture Type: \_\_\_\_\_

SPEC #: **BR11157550**

Approved On: \_\_\_\_\_ Approved By: \_\_\_\_\_

## MR16 GU5.3 Base 4W 12V 60Deg 2700K 85CRI 10-PACK

By Brilliance



### Description

The Brilliance 4 Watt 12V MR16 GU5.3 Bi-Pin is designed to fit in standard low voltage MR16 fixtures. These LEDs are thermally engineered to operate in enclosed fixtures and provide added security by automatically cooling down and reducing lumen output when exposed to extreme heat. Available with a variety of beam angle options in static white 2700K color temperature and Amber or Blue monochromatic colors. Equivalent to a 20 watt halogen. Dimmable with Brilliance Dimmer and most low voltage magnetic transformers. Note: Sold as a 10-pack. Note: Limited beam angle options available for Amber, Blue and 5700K color temperature options.

### Specifications

COLOR	Brown
BODY FINISH	N/A
WATTAGE	4W
DIMMER	Low Voltage Magnetic
DIMENSIONS	1.95"W x 1.89"H
BULB	MR16/GU5.3 (bipin)/4W/12V LED

### Technical Information

LAMP LIFE	50000 hours
BEAM ANGLE	60°
COLOR RENDERING	85 CRI
LAMP COLOR	2700K
LUMENS/WATT	81.25
LUMINOUS FLUX	325 lumens



Shown in brown

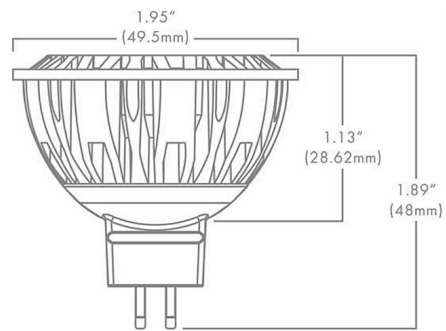

CLICK TO VIEW PRODUCT

Notes: