

Lightology

lightology.com
866-954-4489
05-17-26

Project: _____

Company: _____

Location: _____ Fixture Type: _____

SPEC #: **VCG1243113**

Approved On: _____ Approved By: _____

Dauphine Wall Sconce By Visual Comfort Signature



Description

The Dauphine Wall Sconce brings a traditional look to your interior space. The classic torch like body is topped with a linen shield that casts warm light across your room. Note: Fixture does not cover a standard US junction box and requires a 2 x 4 inch junction box.



Shown in gild / linen

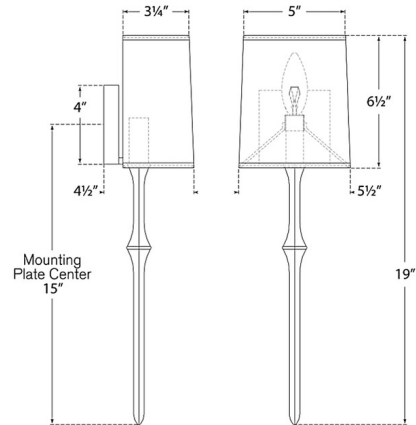

Specifications

COLOR	Linen
BODY FINISH	Gild
WATTAGE	40W
DIMMER	Standard 120V
DIMENSIONS	5.5"W x 19"H x 4.5"D
BULB NOT INCLUDED	1 x B11/Candelabra (E12)/40W/120V Incandescent
OTHER BULB OPTIONS	1 x B11/Candelabra (E12)/120V LED



CLICK TO VIEW PRODUCT

Notes: