

Lightology

lightology.com
866-954-4489
05-24-26

Project: _____

Company: _____

Location: _____ Fixture Type: _____

SPEC #: **FOS1416569**

Approved On: _____ Approved By: _____

Pli Linear Pendant By Foscarini



Description

The Pli Linear Pendant features an elegant folded paper shade recalling the look of draped or ruffled fabric. The paper is formed around a tubular frame which houses the LED light source, which directs light both upwards and downwards, as well as through the paper to produce a translucent glow. Pli is the first lamp designed by Felicia Arvid, whose background in fashion design inspired the pendant's flowing, fabric-like texture. Phase cut or 0-10V dimmable.

Specifications

COLOR N/A
BODY FINISH White
WATTAGE 40W
DIMMER Low Voltage Electronic
DIMENSIONS 33"L x 7.88"W x 7.13"H
BULB NOT INCLUDED 1 x LED/40W/120-277V LED

Technical Information

COLOR RENDERING 80 CRI
LAMP COLOR 2700K
LUMENS/WATT 116.00
LUMINOUS FLUX 4640 lumens

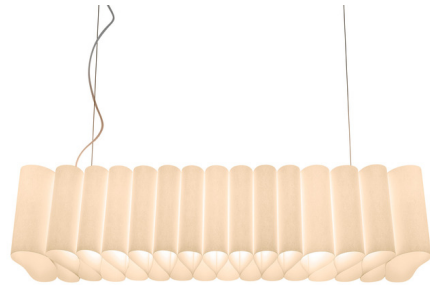

Shown in white

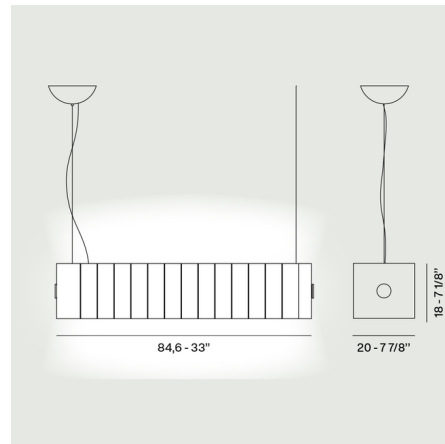

CLICK TO VIEW PRODUCT

Notes: