

# Step Light Round Solid Eyelid



**Description:**

The Step Lite Solid Eyelid Outdoor Light is designed with a 3.5 inch flange and recessed body for flush mounting into canister for concrete masonry, stone or wood, providing illumination of steps and low level features such as exterior paved areas. When used with Hunza mounting canister there are no mounting holes in the flange. The eyelid feature eliminates all upward light, providing an excellent glare-free illuminating effect. Machined from thick aluminum in powder coat finish Green, Bronze or Black, solid Copper, or 316 Stainless Steel with a clear tempered stepped glass lens and high temperature silicon gaskets. UL listed. IP 66 rated for wet locations. Requires mounting canister (DKcan for wood or SLcan for concrete or stone) and low voltage transformer, sold separately.

Shown in: Copper

List Price: \$683.47  
 Our Price: \$478.43

Shade Color: N/A  
 Body Finish: Copper  
 Lamp: 1 x MR16/GU5.3 (bipin)/20W/12V Halogen  
 1 x MR16/GU5.3 (bipin)/12V LED  
 Wattage: 20W  
 Dimmer: Dimmable  
 Dimensions: 3.5"H x 3.5"W x 2.75"D

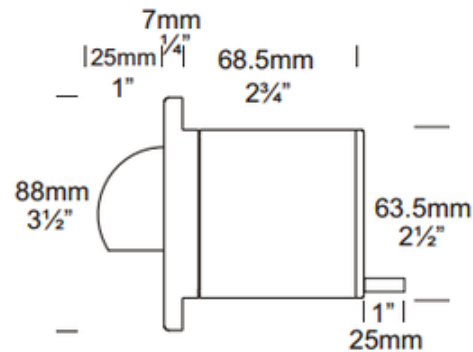

Product Number: <b>HUZ38392</b>			
Company:		Fixture Type:	Date: Apr 21, 2018
Project:		Approved By:	

#0812ES-SLS-003H1-00CO

Fax: (773) 883-6131

Phone: 866-954-4489

Address: 1718 W. Fullerton Ave. Chicago IL 60614

www.Lightology.com