

Lightology

lightology.com
866-954-4489
04-07-26

Project: _____

Company: _____

Location: _____ Fixture Type: _____

SPEC #: **EDG40153**

Approved On: _____ Approved By: _____

Remote 300W 12V Magnetic Transformer

By PureEdge Lighting



Description

300 Watt Remote Magnetic Transformer converts line voltage input to low voltage 12 volt output for powering Monorail, Kable Lite or Fast Jack low voltage lighting systems. The remote transformer must be installed in an accessible location (such as an attic or in a closet), and it is best to keep transformer within 20 feet of the power feed/ junction box to prevent voltage drop. Protected by fast acting secondary circuit breaker.

Dimmable using a 600 watt magnetic low voltage dimmer, sold separately. Some buzzing may occur on low levels and may be reduced with a dimming de-buzzing coil, sold separately. 12 Volt magnetic transformers are LED compatible with 12 volt AC LEDs. ETL listed. Power feed or power feed canopy required, sold separately.



Shown in black

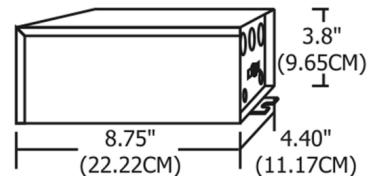

Specifications

COLOR	N/A
BODY FINISH	Black
WATTAGE	300W
DIMMER	Low Voltage Magnetic
DIMENSIONS	8.75"W x 3.8"H x 4.4"D
BULB NOT INCLUDED	N/A



CLICK TO VIEW PRODUCT

Notes: