

Lightology

lightology.com
866-954-4489
07-08-26

Project: _____
Company: _____
Location: _____ Fixture Type: _____
SPEC #: **JUN50554**
Approved On: _____ Approved By: _____

TL575-20 20W Magnetic Remote Driver/Transformer 12V By Juno Lighting



Description

TL575-20 12 Volt 1-Circuit 20 Watt Magnetic Remote Driver/Transformer is rated for incandescent or LED loads 0.50 to 20 watts, 120VAC input. Potted core and coil construction with 13 volt boost tap. Features thermally protected primary, manually resettable, fast-acting magnetic circuit breaker on secondary. Primary and secondary circuits physically and electrically isolated. Resettable magnetic circuit breaker. Incandescent loads can be dimmed with high quality dimmers designed specifically for use with magnetic transformer. LED loads may be dimmed using only dimmers that have been tested and qualified by Juno for use with Juno LED fixtures including: Lutron Diva DVLV-600P, Lutron Nova NLV-600, Lutron Ceano CNLV-600P, or Lutron Skylark SLV-600P. UL Listed. New York City approved. 10.75 inch length x 4.4 inch width x 4.1 inch depth. Compatible with Juno Lighting Trac 12 and Trac 12/25 miniature low voltage track systems using LED or halogen luminaires.



Shown in black

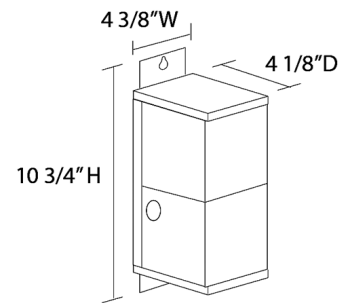

Specifications

COLOR	N/A
BODY FINISH	Black
WATTAGE	20W
DIMMER	Low Voltage Magnetic
DIMENSIONS	10.75"L x 4.4"W x 4.1"D
BULB	N/A



CLICK TO VIEW PRODUCT

Notes: