

Lightology

lightology.com
866-954-4489
05-24-26

Project: _____

Company: _____

Location: _____ Fixture Type: _____

SPEC #: **EMA861586**

Approved On: _____ Approved By: _____

JCD G8 Bi-Pin Base 4.5W 120V 3000K 90CRI 2-Pack

By Emery Allen



Description

The JCD G8 Bi-Pin Base 120 Volt LED retrofit lamp is an energy efficient alternative to incandescent G8 base lamps. Available in 4.5 and 5 watt options. 4.5 watt equivalent to 50 watt halogen; 5 watt equivalent to 60 watt halogen. Fully dimmable with most LED and incandescent dimmers. ETL listed for damp locations. Suitable for enclosed fixtures. Title 20 and Title 24/JA8 listed. Sold as a 2 pack.

Specifications

COLOR	White
BODY FINISH	N/A
WATTAGE	4.5W
DIMMER	Standard 120V
DIMENSIONS	0.63"W x 2.13"H
BULB	JCD/G8/4.5W/120V LED

Technical Information

LAMP LIFE	25000 hours
BEAM ANGLE	360°
COLOR RENDERING	90 CRI
LAMP COLOR	3000K
LUMENS/WATT	100.00
LUMINOUS FLUX	450 lumens



Shown in white

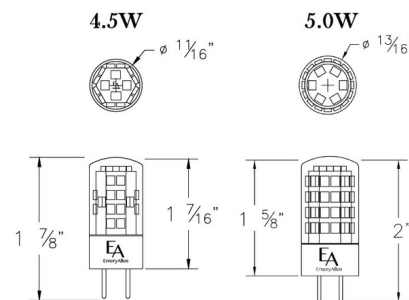

CLICK TO VIEW PRODUCT

Notes: