

Lightology

lightology.com
866-954-4489
05-22-26

Project: _____

Company: _____

Location: _____ Fixture Type: _____

SPEC #: **TWO906347**

Approved On: _____ Approved By: _____

Hydrogen Pendant By Two Parts



Description

The Hydrogen Pendant features a simple spherical shell that is lit within from a seemingly invisible light source. This fixture looks beautiful by itself or pair it with multiples to create a one of a kind look. Available in 1-light, 3-light, 5-light, or 7-light options and three color temperature options. 1-Light includes a 10 Watt 12V driver (2.7L x 1.6W x .9H) which fits inside most junction boxes, TRIAC, ELV, 0-10V dimming. 3-Light includes a 25 Watt 12V driver (3.1L x 1.5W x 1H) which fits inside most junction boxes, TRIAC, ELV, 0-10V dimming. 5-Light and 7-Light options include a 40 Watt 12V driver (3.5L x 2.5W x 1.2H) which fits inside most junction boxes, TRIAC, ELV, 0-10V dimming.

Specifications

COLOR	Clear
BODY FINISH	White
WATTAGE	38.5W
DIMMER	Low Voltage Electronic
DIMENSIONS	40"W x 40"H x 40"D
INTEGRATED LED MODULE	7 x LED/5.5W/120V LED
COUNTRY OF ORIGIN	United States

Technical Information

LAMP LIFE	50000 hours
COLOR RENDERING	95 CRI
LAMP COLOR	3000K
LUMENS/WATT	509.09
LUMINOUS FLUX	2800 lumens



Shown in white / clear

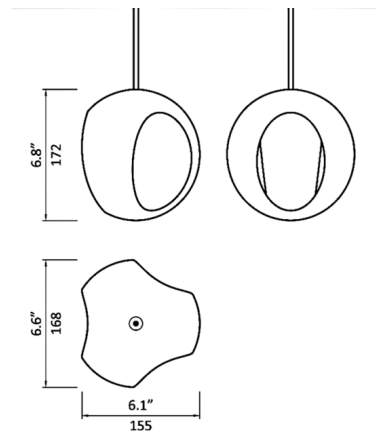

CLICK TO VIEW PRODUCT

Notes: