

melogranoblu

HYDRA SYSTEM

## LEGEND



CLEAR GLASS



FROSTED GLASS



RULED CLEAR GLASS



RULED FROSTED GLASS



METALLIZED



INNER LIGHT



REFLECTED LIGHT



SUSPENSION LAMP

## INDEX

HYDRA SYSTEM	
COMPONENTS	32
GLASSES	36
ACORN	38
ALPHA	40
ACQUA	42
AVATAR	44
BERRY	46
BERRY METAL	48
BETA	52
DATURA	54
DELTA	56
DERVISCI	58
DIESIS	60
GAMMA	62
LAMBDA	66
LHASA	68
OMEGA	70
ONION	74
ORGANIC	76
SIGMA	78
LED CEILING LIGHTS	80

## THE FACTORY OF EMOTIONS

CONCEIVED AND FOUNDED IN 1997 BY ERMANNO ROCCHI AND MASSIMO CREMA, MELOGRANOBLU IS AN ITALIAN INTERIOR LIGHTING COMPANY. OVER THE YEARS, THE COMPANY HAS DEVELOPED A WIDE RANGE OF SOLUTIONS FOR INTERIOR LIGHTING DESIGN, SUITABLE FOR HOMES OR OFFERING MORE IMPRESSIVE INSTALLATIONS FOR LARGE ARCHITECTURAL SETTINGS.

MELOGRANOBLU CREATIONS ARE VERITABLE SPECTACLES OF LIGHT, FOCUSING ON THE SENSORY AND EMOTIONAL EFFECT OF LIGHT THROUGH GLASS.

DESIGN PROJECTS IN WHICH ALL FORMS OF GLASS ARE CONCEIVED AND DESIGNED ACCORDING TO THE EFFECTS THEY CAN GENERATE THROUGH LIGHT.

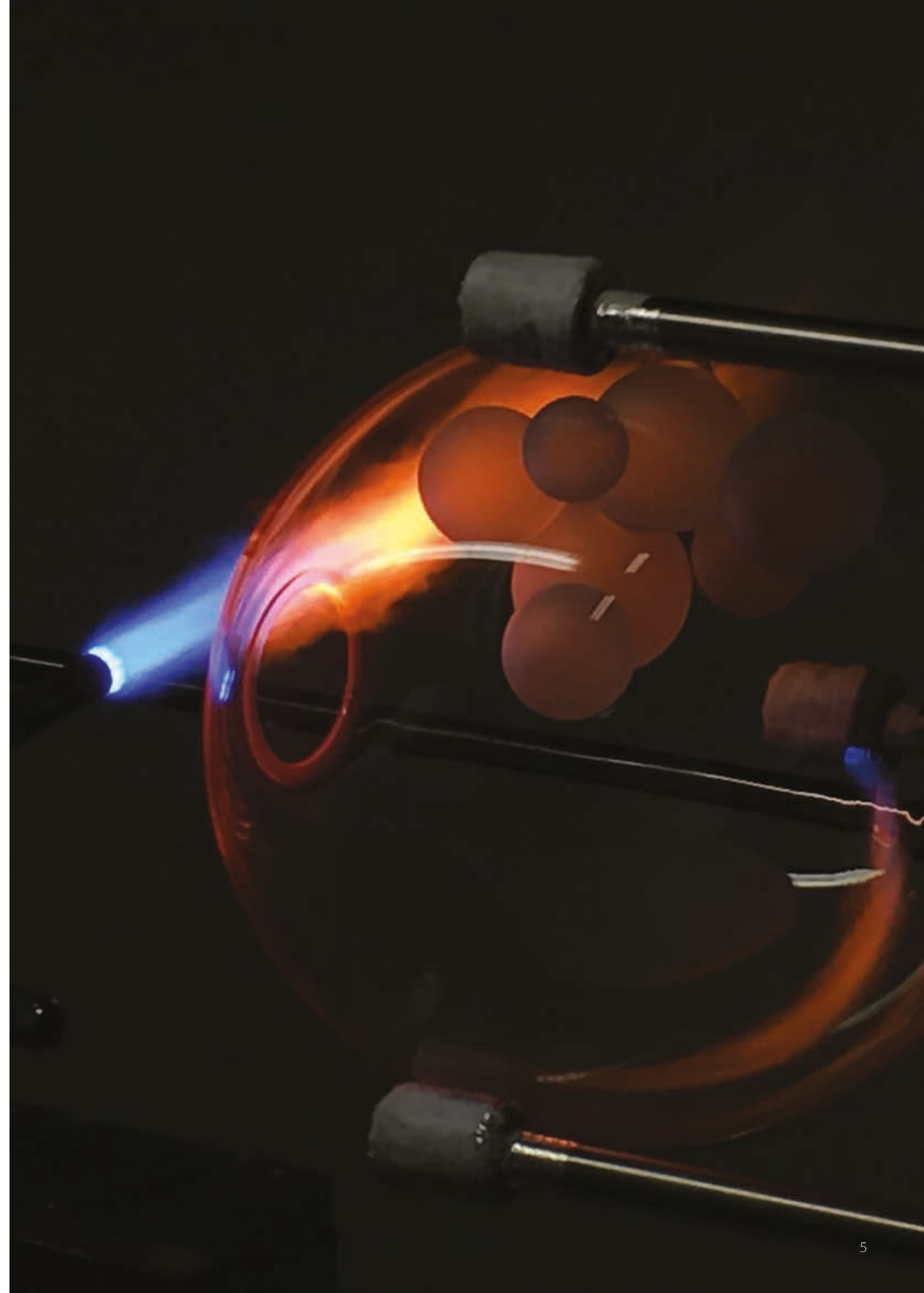

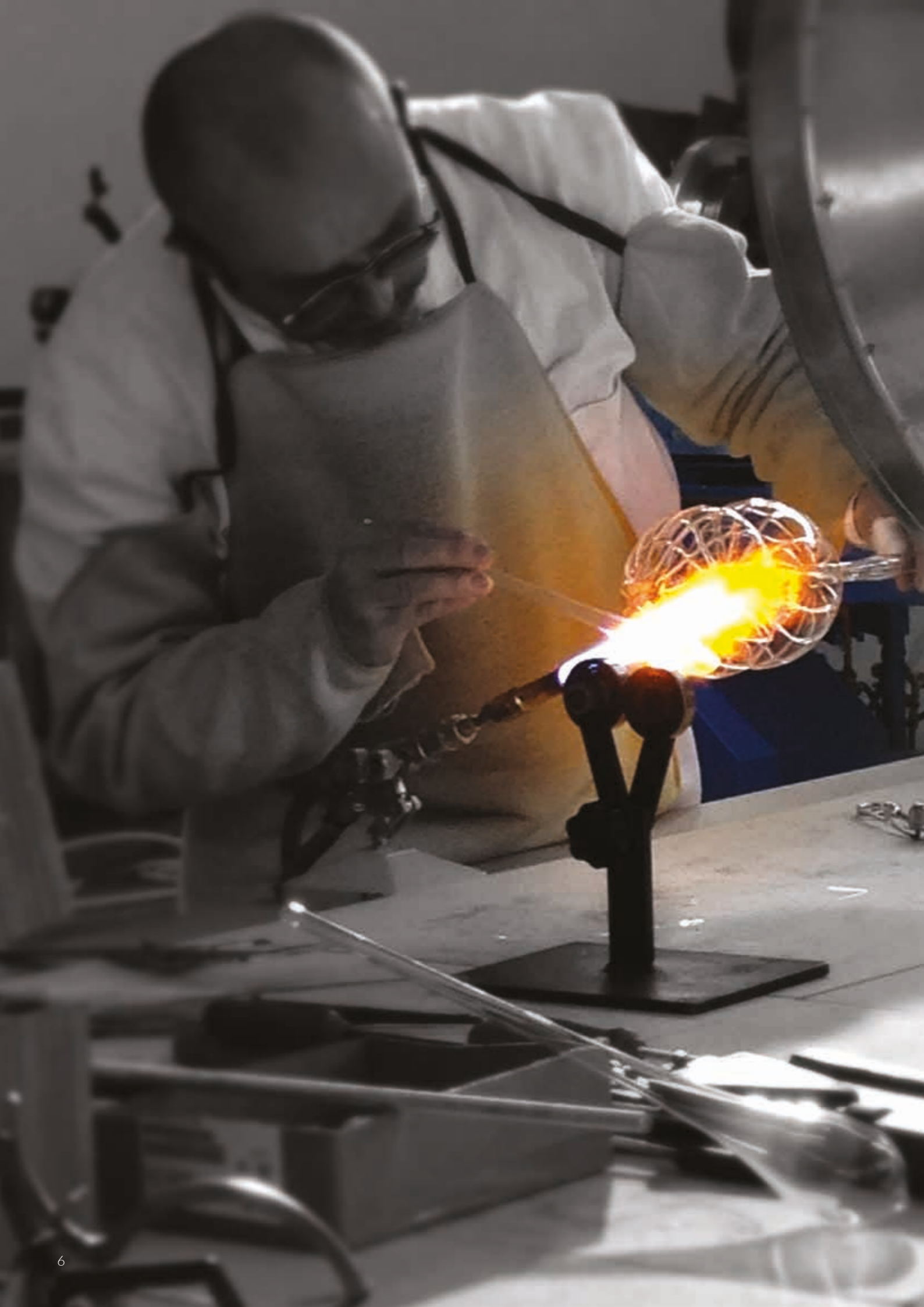

## CRAFTED PRODUCTION AND INDUSTRIAL ORGANISATION

ALL MELOGRANOBLU DESIGNS ARE CONCEIVED, DEVELOPED, ENGINEERED AND PRODUCED IN THE COMPANY. A STRUCTURE ORGANISED TO MANAGE AND GUARANTEE "MADE IN ITALY" QUALITY THROUGHOUT THE ENTIRE PRODUCTION PROCESS.

UNIQUE PIECES, THE SAME YET DIFFERENT SINCE THEY ARE MADE WITH PASSION BY SKILLED HANDS THAT CREATE ARTWORKS FROM GLASS.

## MADE-TO-ORDER

MELOGRANOBLU'S IN-HOUSE GROUP OF DESIGNERS WORKS IN COLLABORATION WITH THE CLIENT, DEVELOPING EACH SPECIFIC DESIGN IDEA TO ACHIEVE A MADE-TO-MEASURE LIGHT INSTALLATION.

MELOGRANOBLU MADE-TO-ORDER DESIGNS, ALL DEVELOPED AND ENGINEERED WITHIN THE COMPANY, ARE DELIVERED TO THE CLIENT COMPLETE WITH DETAILED INSTRUCTIONS TO GUIDE EASY INSTALLATION IN TOTAL SAFETY.



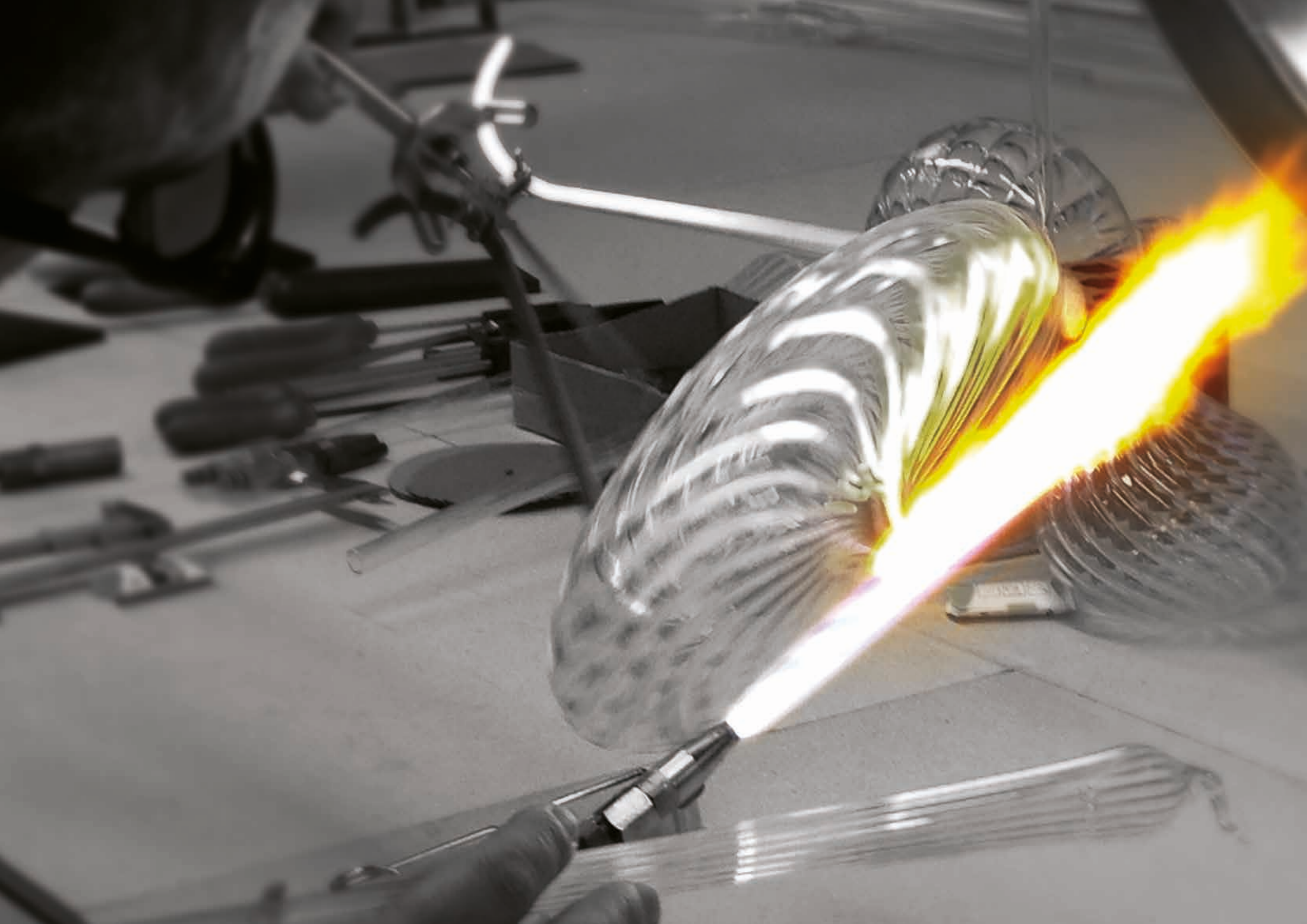



## HYDRA SYSTEM

HYDRA IS A MODULAR LIGHTING SYSTEM FOR INTERIORS CREATED BY MELOGRANOBLU FOR DESIGNING AND CREATING ALLURING AND SOPHISTICATED LIGHTING COMPOSITIONS WITH GREAT EASE.

SHAPES IN BLOWN GLASS, CLEAR OR FROSTED, SUSPENDED USING COLOURED TUBULAR METAL LINKS, REFLECT THE LIGHT IN THE ROOM TO CREATE EVOCATIVE ATMOSPHERES.

VERSATILITY, LIGHTNESS, EASY INSTALLATION AND FREEDOM OF DESIGN ARE ITS DISTINCTIVE FEATURES.

WITH HYDRA YOU CAN CREATE COUNTLESS LIGHT CONFIGURATIONS SUITED TO ALL ARCHITECTURAL INTERIORS, BE THEY RESIDENTIAL OR CONTRACT.

THE IN-HOUSE GROUP OF DESIGNERS WORKS IN CLOSE SYNERGY WITH THE CLIENT IN CREATING SPECTACULAR COMPOSITIONS STUDIED FOR THE SPECIFIC INTERIOR DESIGN PROJECT. STARTING OUT WITH A CONCEPT, IT DEVELOPS A DETAILED SHOP DRAWING COMPLETE WITH INSTALLATION INSTRUCTIONS.





LIGHT CREATES  
EVOCATIVE  
ATMOSPHERES







VERSATILITY  
AND FREEDOM  
OF DESIGN







PRECIOUS  
DETAILS.



TIMELESS  
LIGHTING  
SOLUTIONS







HYDRA SYSTEM

## COMPONENTS

**A** LIGHT SOURCE  
See page 34

**B** FIXING ACCESSORIES  
See page 35

**C** METALLIC MESH ROPES  
See page 35

**D** GLASSES  
See page 36

## A LIGHT SOURCE

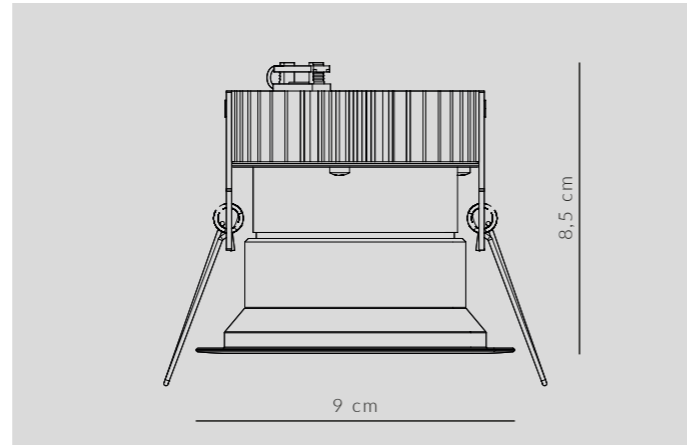

LED recessed projector 10W24Vdc 2700k cri93 optics 6° circular body ø 90 mm.

Hydra System is also customizable with: LED CEILING LIGHT (See page 80) or INNER LIGHTS.

## INNER LIGHTS

METALLIC MESH ROPE CAN BE ELECTRIFIED, TO HAVE LIGHT INSIDE GLASSES.

- ① Special fixing support for false ceiling.
- ② Inner light for Hydra System glasses complete with special G4 pin LED bulb 2,5 W melogranoblu patent.

Additional inner light can be used only with following models: Alpha, Berry metal, Beta, Datura, Delta, Diesis, Gamma ① .

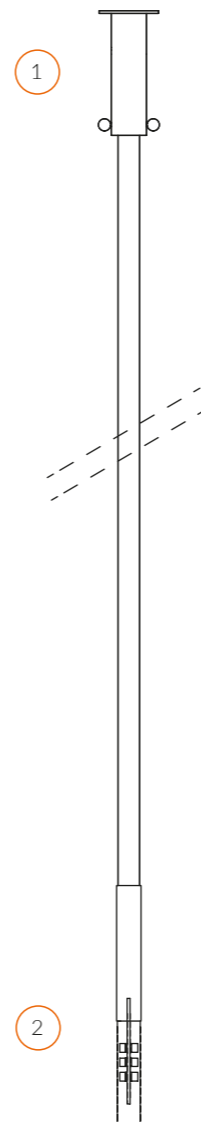

## B FIXING ACCESSORIES



CEILING FIXING SUPPORT



FLOOR FIXING SUPPORT



GLASS FIXING METAL PIN

## C METALLIC MESH ROPES

#T11 Red

#T34 Fuxia

#T39 Orange

#T26 Gold

#T36 Purple

#T35 Wistaria

#T12 China Blue

#T29 Turquoise

#T08 Titanium

#T00 Copper

#T20 Brown

#T07 Silver

#T21 Black



COLOURED METALLIC MESH ROPE TO HANG GLASSES.

Colors in this catalogue may lightly vary because of printing. melogranoblu reserve the right to modify products and colors, without notice, in order to make technical improvements.

# D GLASSES

- 1 ACORN page 38
- 2 ALPHA page 40
- 3 ACQUA page 42
- 4 AVATAR page 44
- 5 BERRY page 46 | BERRY METAL page 48
- 6 BETA page 52
- 7 DATURA page 54
- 8 DELTA page 56
- 9 DERVISCI page 58
- 10 DIESIS page 60
- 11 GAMMA page 62
- 12 LAMBDA page 66
- 13 LHASA page 68
- 14 OMEGA page 70
- 15 ONION page 74
- 16 ORGANIC page 76
- 17 SIGMA page 78

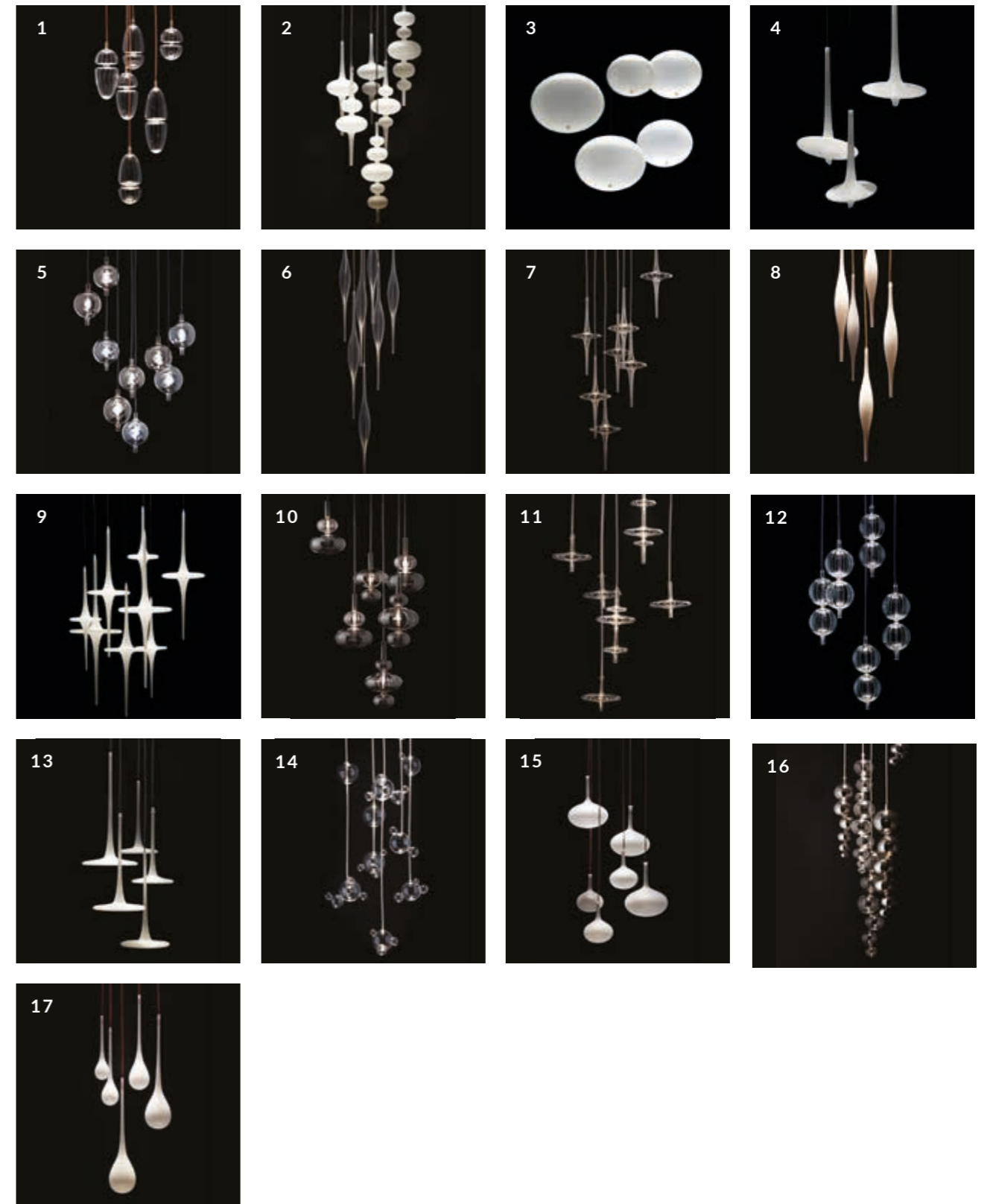

HYDRA

# ACORN



CLEAR OR FROSTED HAND-BLOWN RULED GLASS PENDANT.

4 shapes available: ① h. 21,5 - ø 12,5 cm ② h. 30 - ø 12,5 cm ③ h. 30 - ø 12,4 cm ④ h 38,5 - ø 12,5 cm.



HYDRA

# ALPHA

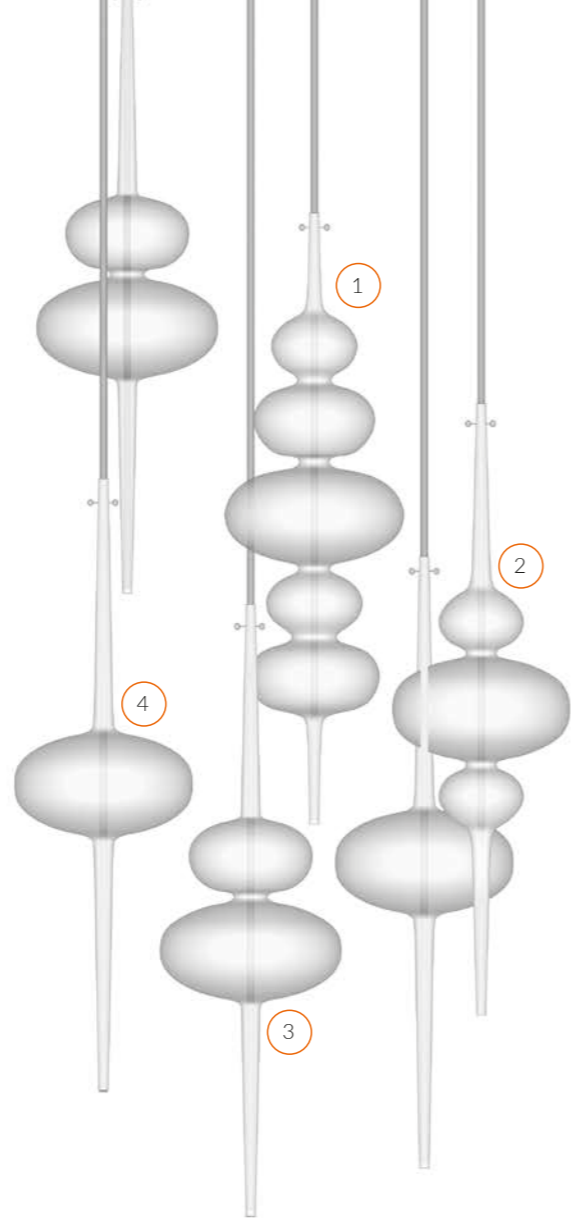

CLEAR OR FROSTED HAND-BLOWN GLASS PENDANT.

4 shapes available: ① h. 45 - ø 15,5 cm ② h. 45 - ø 15,5 cm ③ h. 45 - ø 15,5 cm ④ h. 45 - ø 15,5 cm.  
Additional inner light can be used with this model (see page 34).



HYDRA

# ACQUA

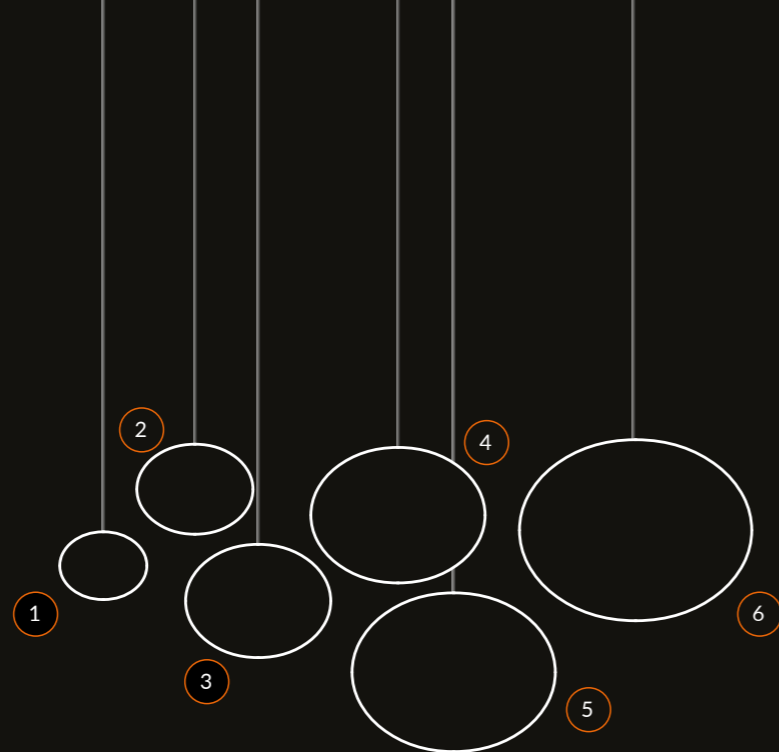

CLEAR OR FROSTED HAND-BLOWN GLASS PENDANT.

6 shapes available: ① ø 9 cm ② ø 12 cm ③ ø 15 cm ④ ø 18 cm ⑤ ø 21 cm ⑥ ø 24 cm.



HYDRA

# AVATAR

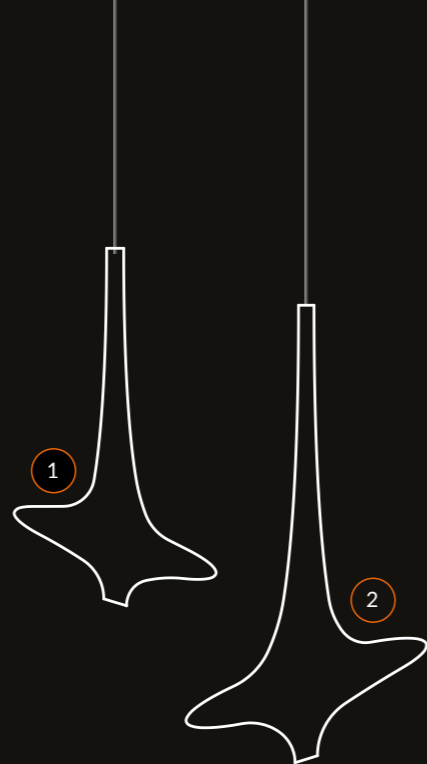

FROSTED OR METALLIZED GOLD HAND-BLOWN GLASS PENDANT.

2 shapes available: ① h. 23 - ø 13 cm ② h. 29,5 - ø 15,5 cm.



HYDRA

# BERRY

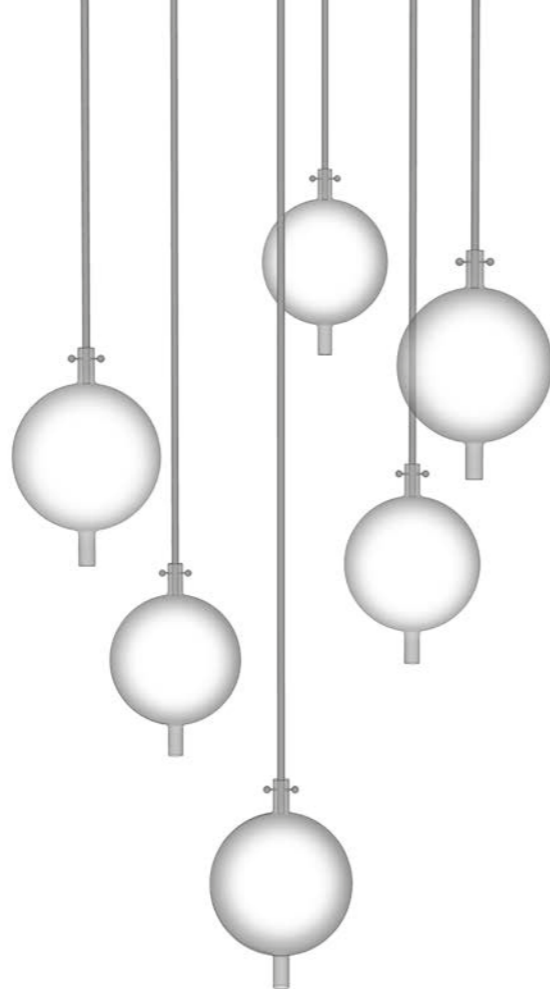

CLEAR HAND-BLOWN GLASS PENDANT.

One size only: h. 24 - ø 16 cm.





HYDRA

## BERRY METAL

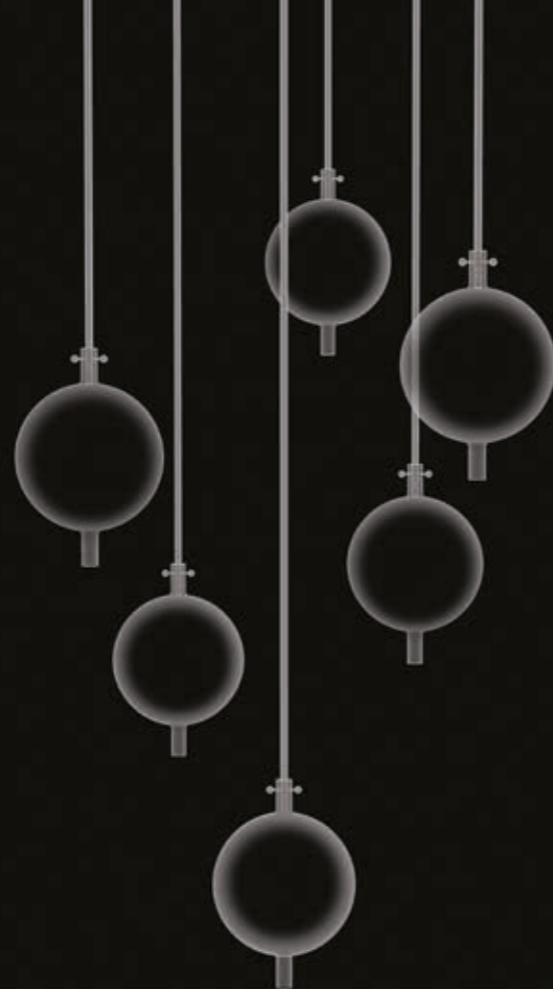

SILVER OR PINK GOLD METALLIZED HAND-BLOWN GLASS PENDANT.

One size only: h. 24 - ø 16 cm.

Additional inner light can be used with this model.





HYDRA

BETA

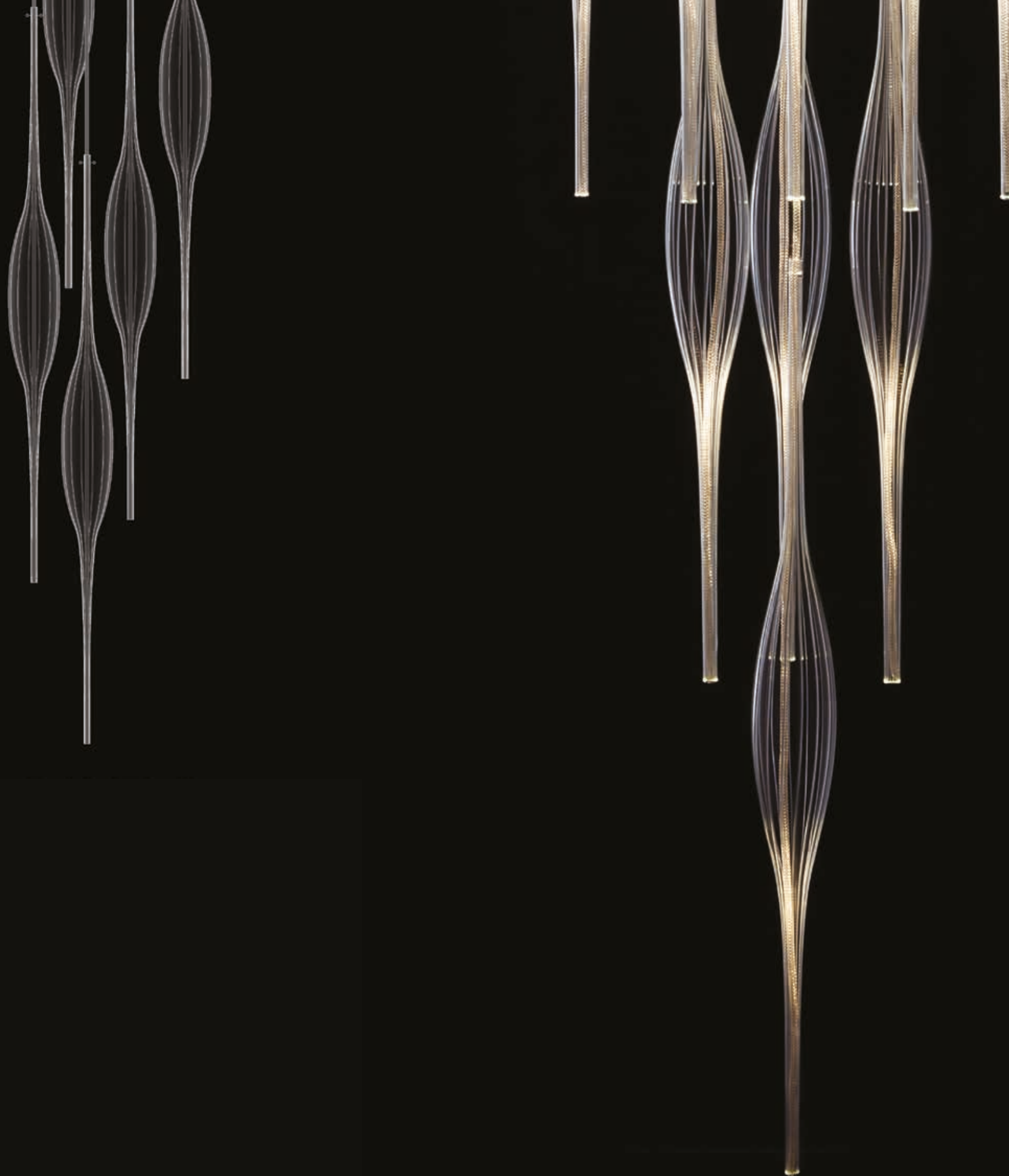

CLEAR OR FROSTED HAND-BLOWN RULED GLASS PENDANT.

One size only: h. 85 - ø 7,5 cm.

Additional inner light can be used with this model (see page 34).



HYDRA

# DATURA



CLEAR OR FROSTED HAND-BLOWN RULED GLASS PENDANT.

One size only: h. 48 - ø 18 cm.

Additional inner light can be used with this model (see page 34).



HYDRA

# DELTA

FROSTED HAND-BLOWN GLASS PENDANT.

One size only: h. 50 - ø 6,5 cm.

Additional inner light can be used with this model (see page 34).



HYDRA

# DERVISCI

CLEAR OR FROSTED RULED BLOWN GLASS PENDANT.

3 shapes available: ① h. 38,5 - ø 12 cm ② h. 48,5 - ø 16 cm ③ h. 58,5 - ø 21 cm.

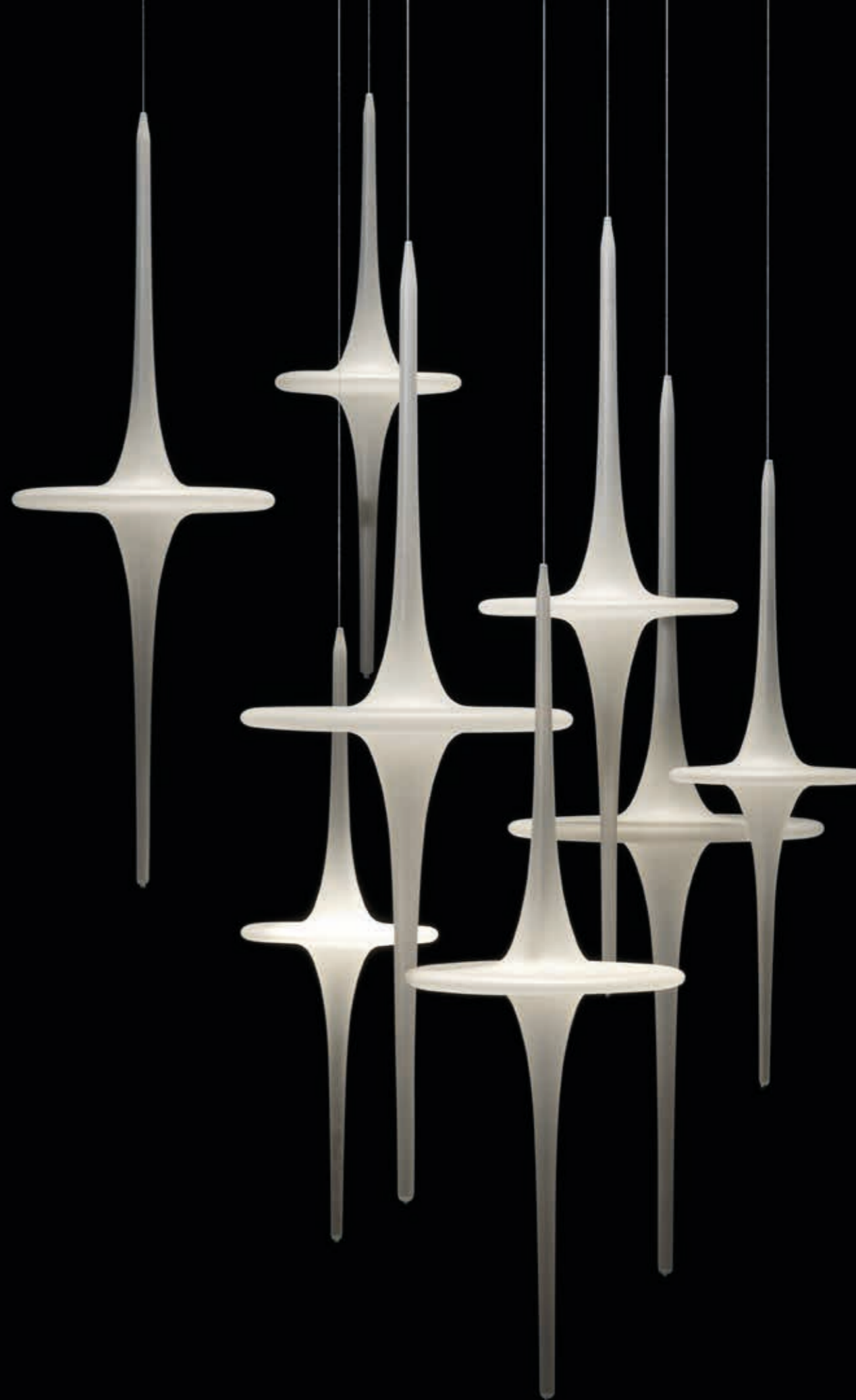

HYDRA

# DIESIS



CLEAR, FROSTED OR METALLIZED HAND-BLOWN RULED GLASS PENDANT.

3 shapes available: ① h. 31 - ø 18 cm ② h. 26 - ø 18 cm ③ h. 26 - ø 18 cm.  
Additional inner light can be used with this model.



HYDRA

# GAMMA

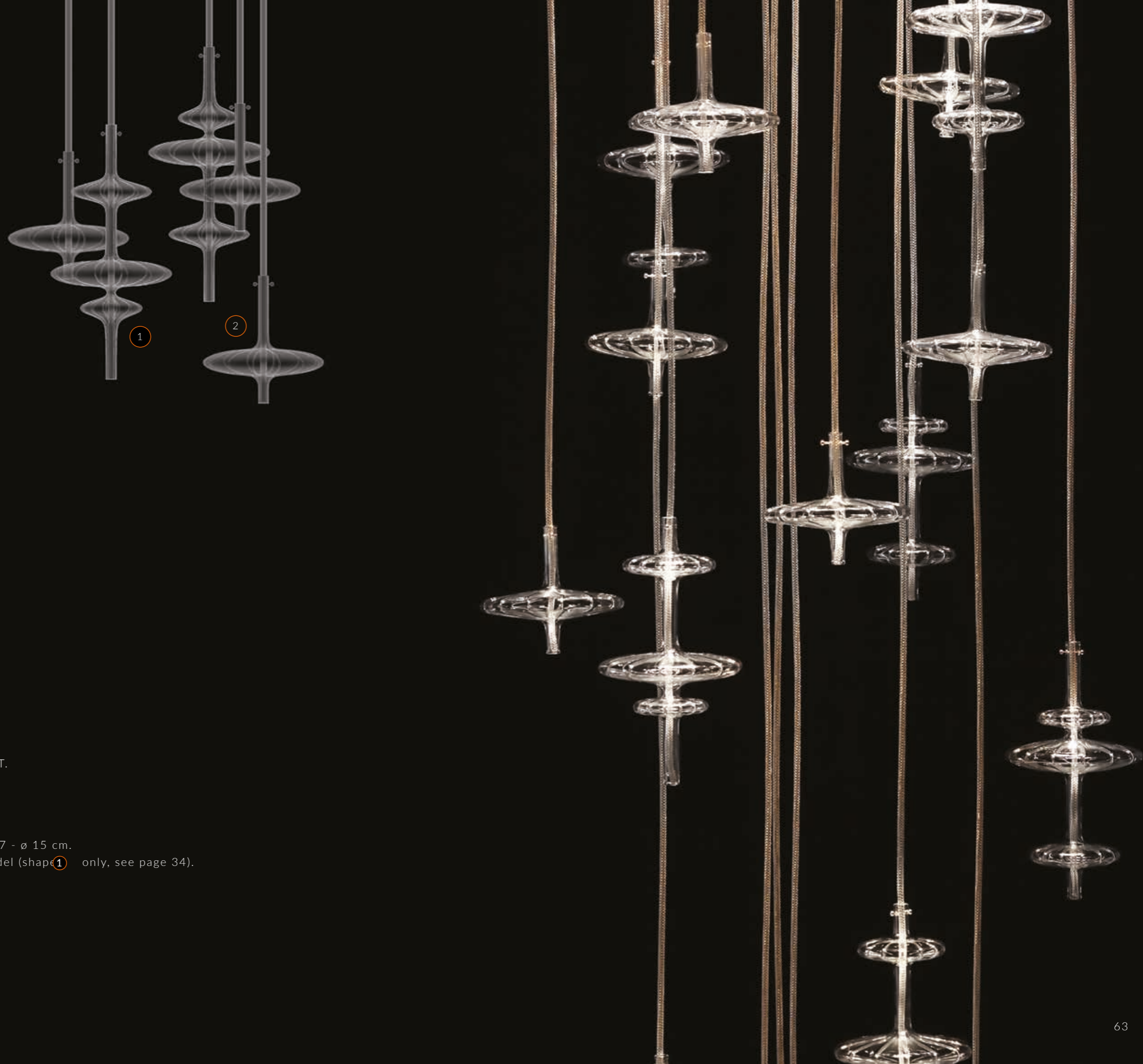

CLEAR HAND-BLOWN RULED GLASS PENDANT.

2 shapes available: ① h. 30 - ø 15 cm ② h. 17 - ø 15 cm.  
Additional inner light can be used with this model (shape ① only, see page 34).







HYDRA

# LAMBDA



CLEAR OR FROSTED HAND-BLOWN RULED GLASS PENDANT.

One size only: h. 31 - ø 10,5 cm.



HYDRA

# LHASA

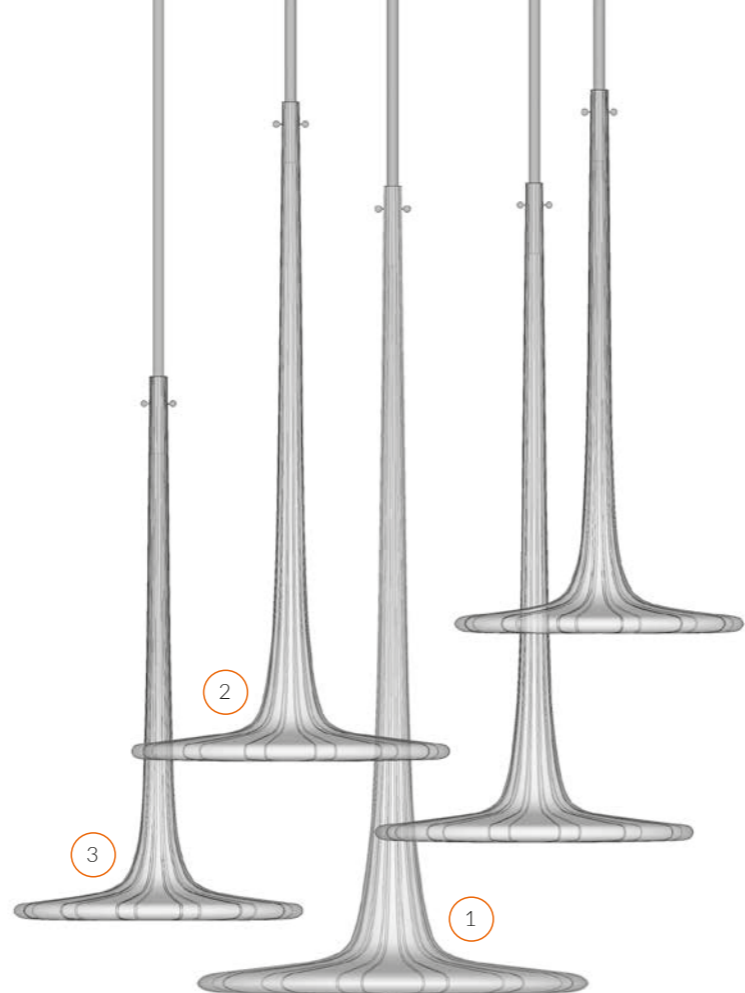

CLEAR OR FROSTED HAND-BLOWN RULED GLASS PENDANT.

3 sizes available: ① h. 56 - ø 27 c ② h. 45 - ø 22 ③ h. 37 - ø 20 cm.



HYDRA

OMEGA

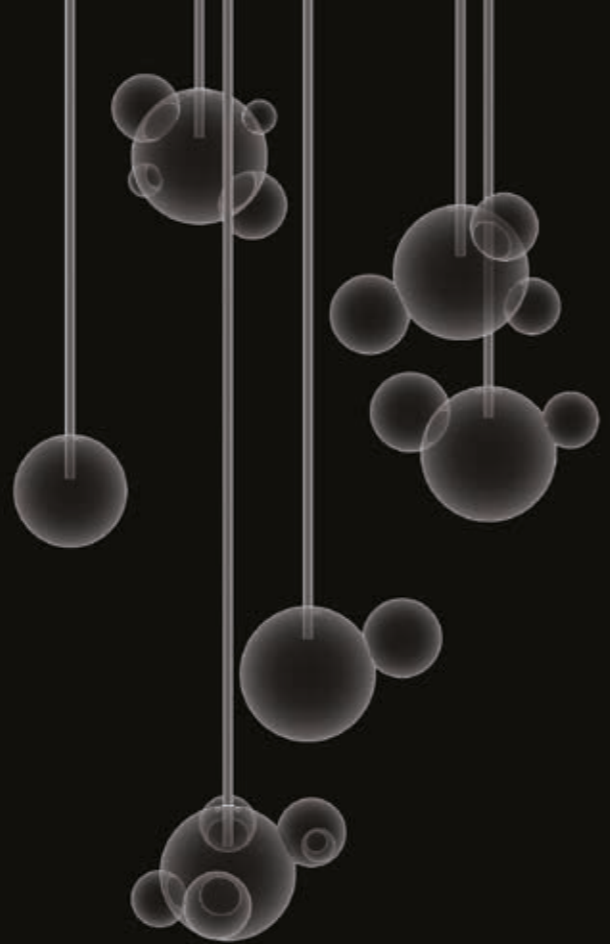

CLEAR HAND-BLOWN GLASS PENDANT.

8 shapes available. From ø 8 up to ø 23 cm.





THE BEAUTY OF  
NATURAL IMPERFECTION

HYDRA

# ONION

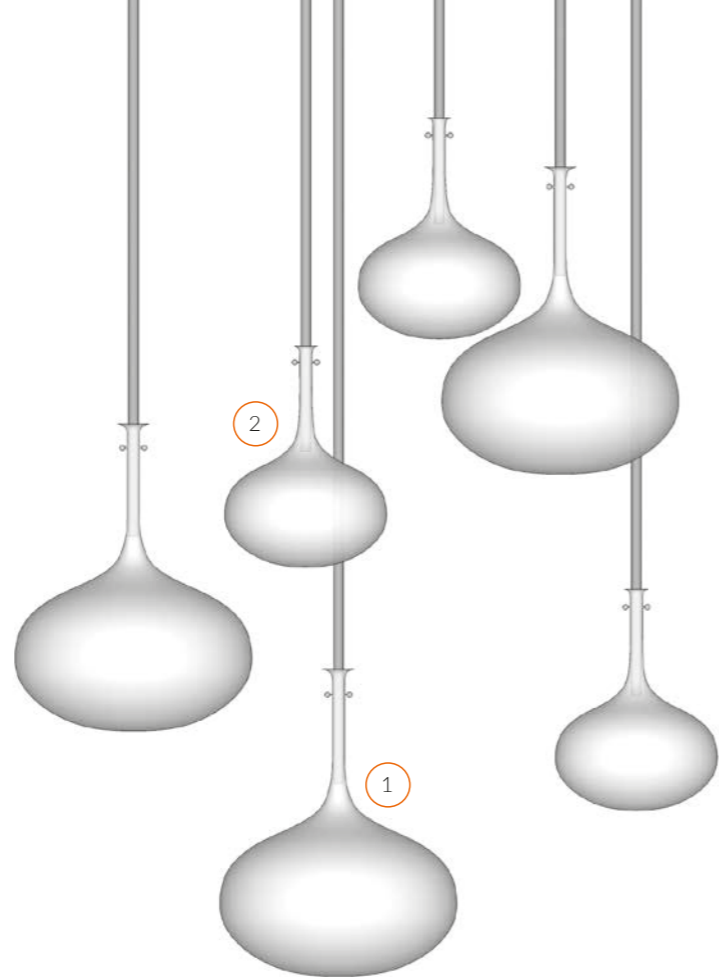

FROSTED HAND-BLOWN GLASS PENDANT.

2 sizes available: ① h. 25 - ø 19 cm ② h. 18 - ø 13 cm.



HYDRA

# ORGANIC



CLEAR OR METALLIZED HAND-BLOWN GLASS PENDANT.

3 shapes available: ① h. 70 - ø 18 cm ② h. 50 - ø 15 cm ③ h. 30 - ø 18 cm.



HYDRA

# SIGMA

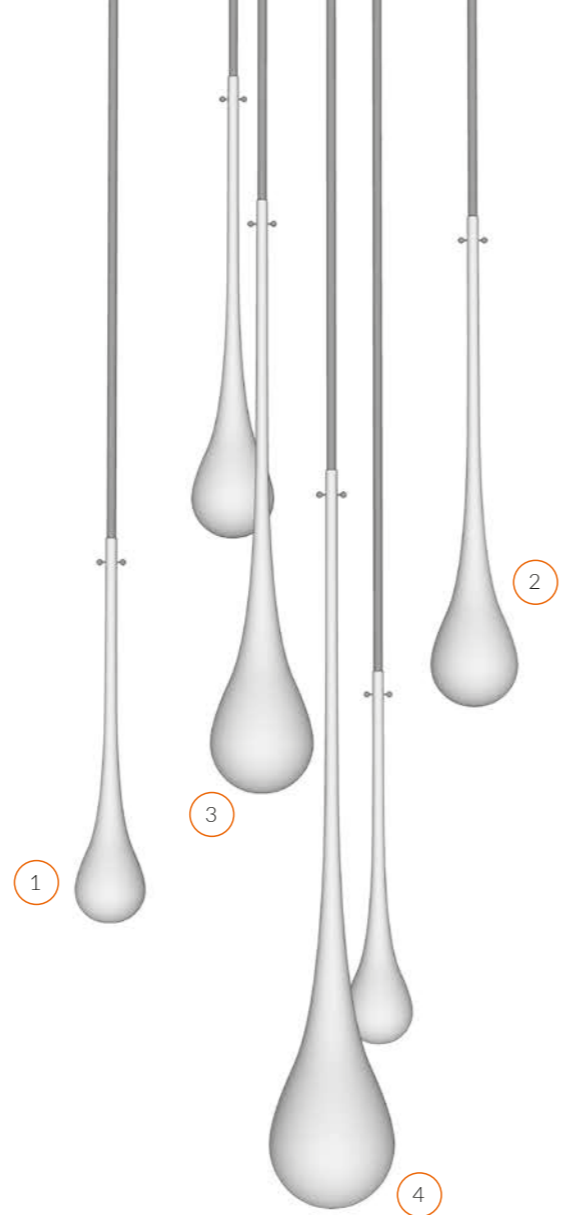

CLEAR OR FROSTED HAND-BLOWN GLASS PENDANT.

4 sizes available: ① h. 35 - ø 7 cm ② h. 45 - ø 8 cm ③ h. 55 - ø 10 cm ④ h. 65 - ø 11 cm.





HYDRA SYSTEM

## LED CEILING LIGHTS

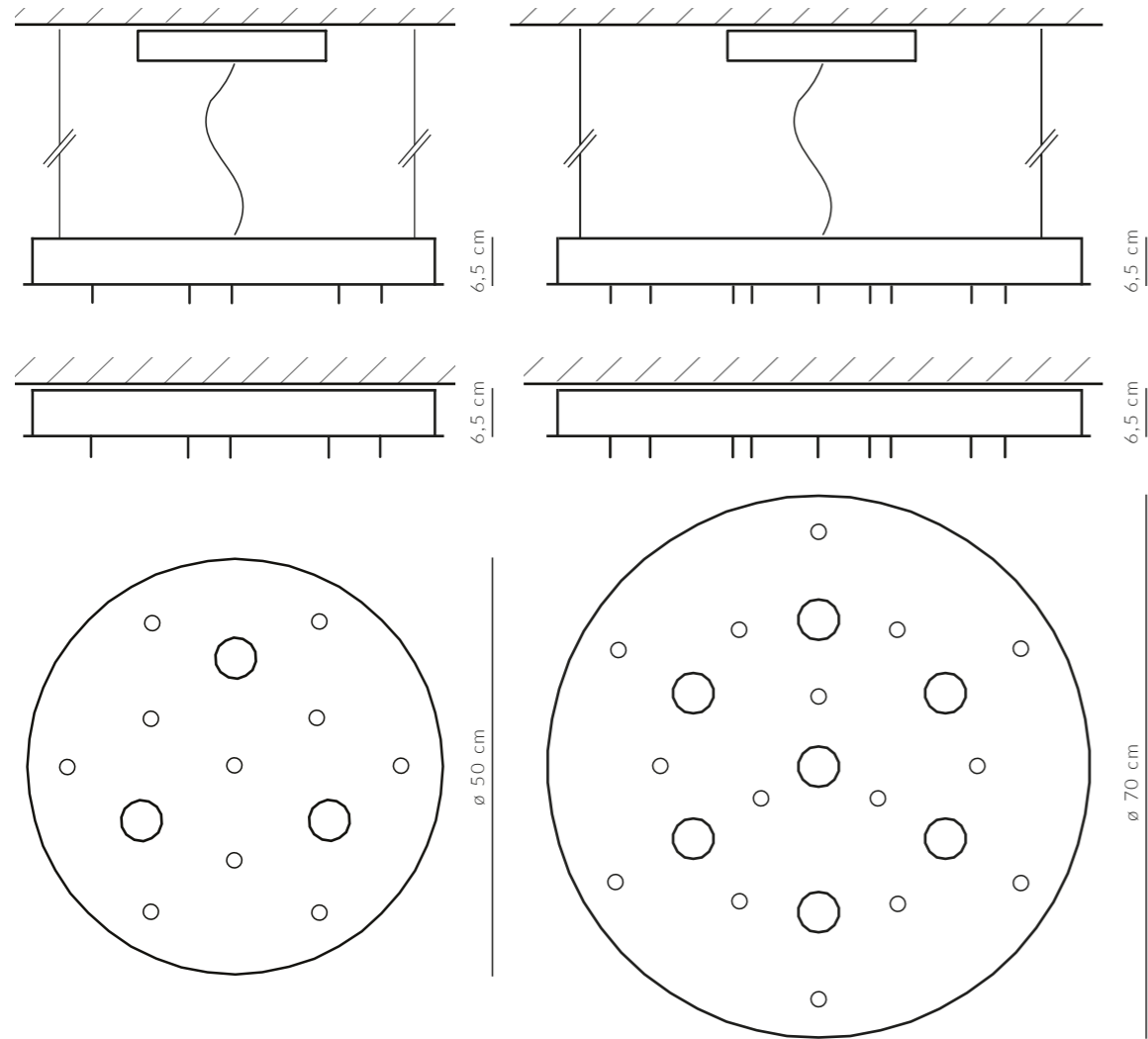

### ROUND METAL CEILING.

SMALL\_ø 50 cm. Varnished or mirror finishing.  
3 x 10W power LED dimmable, 2700k optic 10°.  
10 fixing supports for metallic mesh ropes.

LARGE\_ø 70 cm. Varnished or mirror finishing.  
7 x 10W power LED dimmable, 2700k optic 10°.  
15 fixing supports for metallic mesh ropes.

melogranoblu can design and produce customized ceiling lights.



# CREDITS

COPYRIGHT

© 2023 by melogranoblu srl



CATALOGUE DESIGN

BABOL COMMUNICATION  
[www.babolcommunication.com](http://www.babolcommunication.com)

